

## Safe DC SDC-M IP

### Micro-UPS DC



SDC-M IP 12 V-24 V

DIN1 / DIN2

BACnet IP / HTTPS / SNMP



EN Operating Instructions



<b>1. List of product models</b>	<b>3</b>
<b>2. Safety</b>	<b>3</b>
<b>3. Directives and environment and public health protection</b>	<b>4</b>
<b>4. Definition of the symbols</b>	<b>4</b>
<b>5. General Information</b>	<b>5</b>
5.1 The company	5
5.2 Purpose of the document	5
5.3 Related documentation	5
5.4 Intended audience	5
5.5 Indicator labels	5
<b>6. The product</b>	<b>6</b>
6.1 Description	6
6.2 Operating principle	6
6.3 Schematic diagram	7
6.4 Product view	7
6.5 Scope of delivery	7
<b>7. Energy storage</b>	<b>8</b>
7.1 Available storage option	8
7.2 Technology	8
7.3 Autonomy curves	9
7.4 Autonomy duration	9
<b>8. Installation</b>	<b>10</b>
8.1 Positioning / Installation on support	10
8.2 Connection	11
8.2.1 Connection specifications	11
8.2.2 Wiring	11
<b>9. Commissioning</b>	<b>14</b>
9.1 Communication protocols	14
9.2 Installing the root certificate	14
9.3 Assigning an IP address	15
9.4 Login page – Logging onto the product	15
9.5 Configuration page – General settings' configuration	16
9.6 Network page – IP connection and Ethernet information configuration	17
9.7 Power Supply page – Power supply configuration	20
9.8 System State page – Access to system information	21
9.9 Log page – Access to event log	22
9.10 Factory configuration reset	25
9.11 Product switch-off	25

<b>10. Operation</b>	<b>26</b>
10.1 Local report on product	26
10.2 Remote report – Communication	27
10.2.1 Accessible data	28
10.2.2 HTTPS Protocol	29
10.2.3 SNMP Protocol	29
10.2.4 BACnet IP Protocol	31
<b>11. Maintenance and troubleshooting</b>	<b>40</b>
<b>12. Technical data</b>	<b>42</b>
12.1 Electrical characteristics	42
12.1.1 Electrical characteristics of the power supply	42
12.1.2 Electrical output characteristics	44
12.1.3 Functional characteristics	45
12.1.4 Peak current	45
12.2 Mechanical characteristics	46
12.3 Environmental specifications	46
12.4 Standards	47
12.4.1 Safety standards	47
12.4.2 EMC standards	47
<b>13. Warranty and Product Returns</b>	<b>48</b>
13.1 Warranty	48
13.2 Product Returns	48
13.2.1 Product under warranty	48
13.2.2 Product not under warranty	49

## 1. List of product models

---

These operating instructions apply to all products in the table below.

Models	Code
SDC-M 12V 3D DIN1 IP	81230113
SDC-M 12V 3G DIN2 IP	81233123
SDC-M 24V 3D DIN1 IP	81430113
SDC-M 24V 3G DIN2 IP	81433123

Table 1.1: List of product models

## 2. Safety

---

These operating instructions contain all the instructions to follow in order to install, commission and operate the **SDC-M IP** Uninterruptible Power Supply. It is recommended to follow them very carefully to ensure an optimum functioning of the product.

It is vital to read the Safety Precautions before installing or starting to operate this product.

### Safety Precautions:

**SDC-M IP** is a Micro-UPS DC designed to be connected to the public 110 V / 240 V mains network. It must not be installed outdoors. It ensures continuity of service for equipment in case of power failure. The lithium backup function is integrated into the product.

- A disconnect-switch or circuit-breaker shall be installed upstream according to standards.
- To avoid electric shock, disconnect-switch or circuit-breaker must be open when commissioning or operating maintenance.
- The operation must be performed by qualified personnel only.
- During installation, connect the ground wire first and disconnect it last when dismantling.
- The equipment is only designed to be used in an enclosure with restricted access (IP30 control cabinet), and to be installed on a concrete surface or any other non-combustible surface.
- The product can be installed horizontally or vertically.
- EN 62368-1 conformity (This equipment is not suitable for use in locations where children are likely to be present).
- Sufficient convection must be guaranteed (minimum top and bottom clearance space 30 mm).
- Size cables according to the maximum current input / output.
- Observe the thermal and mechanical limits.
- Provided Battery is Li-ion type.
- Caution! There is a risk of explosion if battery is replaced by wrong model.
- When used, recycle product and battery according to instructions.
- For prolonged storage or disconnection, switch off the mains and press the stop button back-up function (see Figure 6.2 in chapter 6.4: Disconnect backup push-button).
- The backup is maintenance-free. Do not open it.

### 3. Directives and environment and public health protection

The SLAT company is, through their products, committed to protecting the environment and the public health and complies with the corresponding directives.

SLAT develops and manufactures all its products in accordance with the environmental directives RoHS (Restriction of Hazardous Substances) and WEEE (Waste of Electrical and Electronic Equipment).



At its end of life, the product has to be recycled. For end-of-life recycling, a plug-in connector enables qualified professionals independent from SLAT to easily remove the backup.



The SLAT products are compliant with the CE directives.



### 4. Definition of the symbols



Conformity of the product with the requirements of the European directives.



**WEEE (WASTE ELECTRICAL AND ELECTRONIC EQUIPMENT)**

Disposal of the product in an appropriate collection and recycling structure. This product should not be disposed of with household waste.



**RoHS (RESTRICTION OF HAZARDOUS SUBSTANCES)**

Compliance with the European Directive restricting the use of certain hazardous substances in electrical and electronic equipment.



Protective earth terminal.



Caution, risk of electric shock.

## 5. General Information

---

### 5.1 The company

To meet its customers' requirements more effectively:

- SLAT has been designing and manufacturing all its products in accordance with the ISO 14001 standard v15.
- SLAT recycles its products at the end of their life cycle, by means of its recycling program.

### 5.2 Purpose of the document

The operating instructions provide the information necessary for the positioning, the connection, the configuration and the operation of the **SDC-M IP** equipment.

These instructions are also available in PDF format at [www.slat.com](http://www.slat.com).

### 5.3 Related documentation

The following documents are associated with these operating instructions:

- Installation manual
- Commercial brochure

This documentation is available at [www.slat.com](http://www.slat.com).

### 5.4 Intended audience

The operations described in this document should be performed only by authorized trained staff.

### 5.5 Indicator labels

This document comprises three types of important notices.

The type of notice informs you of the potential consequences in the case of non-compliance with the instructions.

These consequences are not exhaustive and are sorted in order of ascending risk:



---

#### **IMPORTANT REMARK!**

**Contains additional information. Non-compliance will not cause damage to equipment or personal injuries.**

---



---

#### **CAUTION!**

**Equipment and goods can be seriously damaged or people seriously injured if the precautions for use are not followed.**

---



---

#### **DANGER!**

**Non-compliance may result in serious injury or death.**

---

## 6. The product

### 6.1 Description

**Micro-UPS with lead and cadmium-free "Smart Backup Inside" with very long service life.**

SDC-M IP are communicating Micro UPS (Uninterruptible Power Supply) of the Safe DC range dedicated to control command applications. They ensure the continuity of service of the equipment they supply and maintain communication with the supervisor in the event of a power failure.



#### Main functions

- Keeps control of the Smart Building's sensitive equipment in case of a power failure or glitch.
- Integrated LiFePO<sub>4</sub> backup, very long service life.
- Filters electromagnetic disturbances.
- Avoids the reporting of false alarms to the supervisor due to network glitches.
- Delivers a constant voltage to equipment.
- Output voltage can be adjusted via the HTTPS website.
- Restart function.
- Open communication protocols: SNMP, HTTPS and BACnet IP).

#### Built-in functions

- Operates in power-saving mode when the backup is charged.
- Stealth mode with controllable operational maintenance.
- Indicates the % of remaining autonomy.
- 2 SDC-M IP can be configured in parallel without accessories for an increase in power, in backup duration or a 100% redundancy.
- Provides selectivity of the electrical protections of the equipment.

#### Benefits of the SDC-M IP

- Ultra-compact & Plug and Play.
- Performs self-diagnostic and that of its environment.
- Lead-free, cadmium-free backup, 100% recyclable.
- Service life of more than 10 years.

### 6.2 Operating principle

When connected to the mains, the emergency power supply SDC-M IP stores energy and continuously powers the connected devices.

When the mains fail, the built-in emergency supply continues to provide power to the connected devices without interruption.

In the event of a complete discharge, the recharging time to 100% of the backup will be in any case less than 20 hours with mains present.

### 6.3 Schematic diagram

The visual below shows the product diagram:

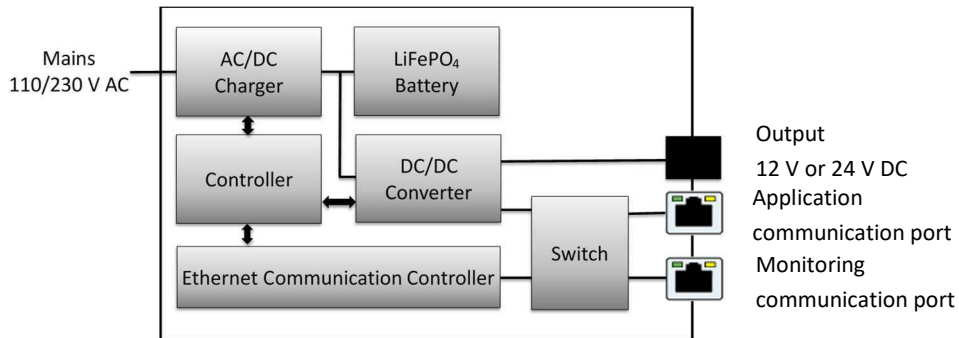

Figure 6.1: Schematic diagram

### 6.4 Product view

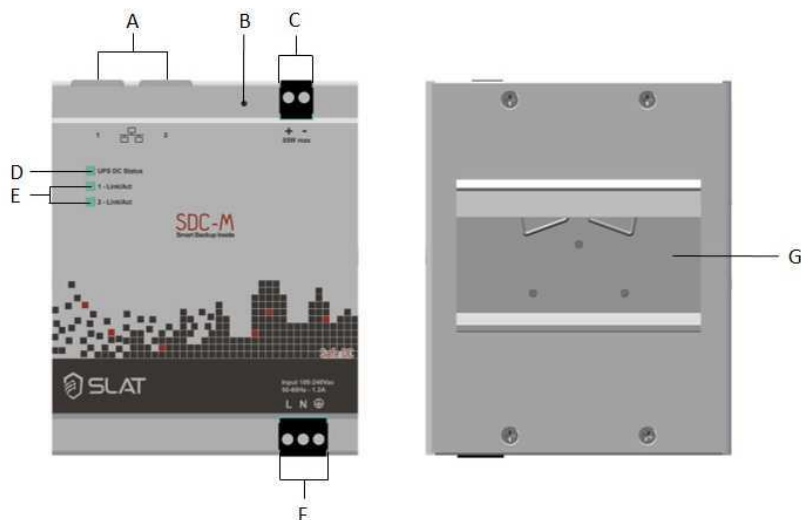

Figure 6.2: Product view

	Name	Use
A	Ethernet port	The communication uses an Ethernet connection and the SNMP, HTTPS or BACnet IP protocol to retrieve detailed product information (see chapter 10.2).
B	Disconnect backup push button	The push button is used to switch off the power supply once the mains power is cut or to return to the factory configuration when the mains is present.
C	DC Output	User voltage output
D	Status light (Status LED)	The light indicates the product status (see chapter 10.1).
E	Ethernet status light (Ethernet LED)	The lights indicate the status ("Link") and the activity ("Act") for each Ethernet connection (see chapter 10.1).
F	Mains input	Mains input
G	Rail attachment	Attachment to fix the box to a DIN rail.

Table 6.1: Elements on the product faces

### 6.5 Scope of delivery

The product is delivered with its installation manual.

## 7. Energy storage

### 7.1 Available storage option

SLAT products are combined with batteries or backup systems. They are used as emergency supplies in the event the mains voltage disappears. The available autonomy then depends on the capacity of the built-in backup.

In the **SDC-M IP** the backup system is already built-in (Smart Backup Inside). According to the need, the product is fitted with different backups. For the DIN1 and DIN2 versions of the SDC-M IP, two backup packs are available. The Table 7.1 presents their minimum guaranteed capacity.

Backup D	Backup G
20 Wh	80 Wh

Table 7.1: Backup versions

### 7.2 Technology

The technology behind the SDC-M IP backup is Lithium-Iron-Phosphate ( $\text{LiFePO}_4$ ).  $\text{LiFePO}_4$  offers the best safety characteristics of any Lithium storage system (see Figure 7.1). This includes better resistance to impacts and to extreme temperatures.

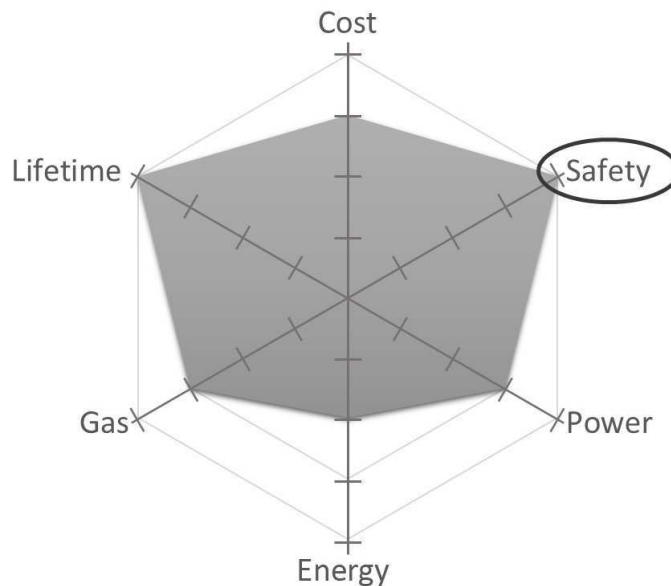

Figure 7.1:  $\text{LiFePO}_4$  characteristics

All SDC-M IP backups have the following characteristics:

- Lithium-Iron-Phosphate technology ( $\text{LiFePO}_4$ )
- No risk of thermal runaway
- Storage: 9 months without recharging
- 10 years' service life @ 25°C
- Lead-free, cadmium-free, 100% recyclable

### 7.3 Autonomy curves

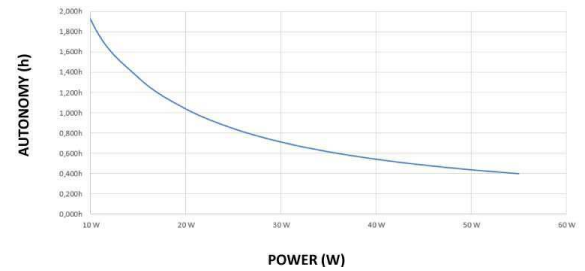
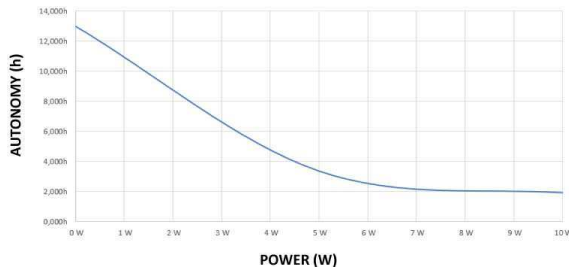

Figure 7.2: Autonomy curves Backup D at 20°C

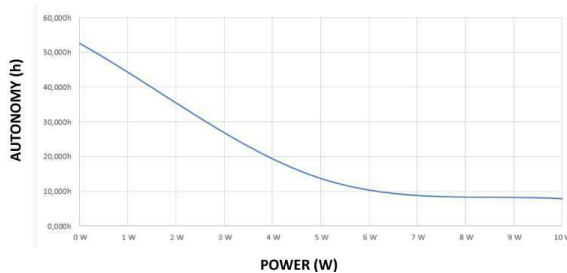

Figure 7.3: Autonomy curves Backup G at 20°C

### 7.4 Autonomy duration

	Backup D	Backup G
<b>Operating power</b>	<b>Autonomy expressed in hours and minutes</b>	
0 W	12h59	52h40
5 W	3h22	13h41
10 W	1h55	7h50
15 W	1h21	5h29
20 W	1h02	4h12
25 W	0h50	3h25
30 W	0h42	2h52
35 W	0h36	2h29
40 W	0h32	2h11
45 W	0h28	1h56
50 W	0h26	1h45
55 W	0h23	1h36

Table 7.2: Autonomy vs Power vs Used backup at 20°C

A part of 20 Wh of the backup D or 80 Wh of the backup G is used for the operation of the SDC in autonomy mode.

To obtain the autonomy times at 55°C please apply a multiplication coefficient of 1,052.

To obtain the autonomy times at -10°C please apply a multiplication coefficient of 0,614.

## 8. Installation

---

### 8.1 Positioning / Installation on support

The product must be installed according to the EN 62368-1 standard.

It can be fitted inside a non-ventilated electrical equipment cabinet. Product cooling by natural convection requires a top/bottom clearance of at least 30 mm.



---

**DANGER!**

This product must be installed in an IP30 rated cabinet.

---

#### Assembly instructions

The DIN1 and DIN2 boxes of the SDC-M IP are designed to be fixed to a DIN rail:

1. Position the top part of the attachment (on the rear of the product) on the top part of the rail, tilting the product backwards. Make sure the clip is placed behind the rail.
2. Clip the product onto the rail by returning it to a vertical position.

Figure 8.1 shows how the box must be positioned on the DIN rail once assembled.

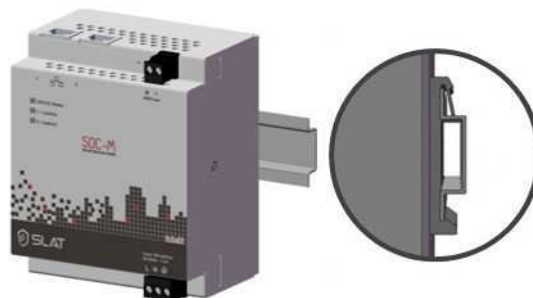

Figure 8.1: Position on DIN rail



---

**CAUTION!**

To prevent the product from falling, make sure it is securely attached to the bottom and top of the rail!

---

## 8.2 Connection

### 8.2.1 Connection specifications

Mains	0.3 mm <sup>2</sup> ... 2.5 mm <sup>2</sup>
User output	0.3 mm <sup>2</sup> ... 2.5 mm <sup>2</sup>
Communication	Ethernet cable Cat 5 or more / shielded or unshielded / straight or twisted cable
Length to be stripped	7 mm
Tightening torque	0.5 Nm ... 0.6 Nm
Connections	Screw terminals, plug-in connectors Ethernet ports (RJ45 connectors)

Table 8.1: Connection specifications



#### **DANGER!**

The wire sectional area must be chosen according to the operating current.

### 8.2.2 Wiring



Figure 8.2: Wiring

After installing the product on its support, the wiring must be carried out. In this way, the emergency power supply (the product) is connected to the application, the supervisor and the mains.

Symbols have been placed on the product (above or below the connectors) to facilitate connection (see also Figure 8.2).

### Wiring methods

The wires for mains input and output are attached to the product using plug-in connectors (the two black parts on Figure 8.2). This makes it possible to carry out the wiring in two different ways:

1. Connect the wires directly to the product

Connect the wires according to the symbols indicated on the product, using a regular screwdriver.



**CAUTION!**

To avoid breaking the connector, comply with the screw tightening torque indicated in Table 8.1.

2. Connect the wires to the unplugged connectors and then connect them to the product.

Pull the connectors to remove them from the product. Connect the wires according to the symbols on the product, using a regular screwdriver. Put the connectors back on the product.



**CAUTION!**

To avoid wiring mistakes, make a careful note of the positioning of the connectors and their respective symbols.

The Ethernet ports are auto MDI-X, such that either straight-through or twisted cables can be used.

### Connection



**DANGER!**

To connect the wires, the application must be switched off. The upstream circuit-breaker of the application must be open!



**DANGER!**

The stripped ends of the mains cables must be crimped before being connected to the product terminals!

The wires are connected according to the following steps:

1. Connect the emergency power supply to the application

The product is connected to the application by the two-point connector (top right). The initial output voltage is set to the rated value.

2. Connect the power supply to the mains

Above the three-point connector (bottom right), the type of wiring is indicated by 3 symbols:

- L Line wire
- N Neutral wire
-  Ground wire



**DANGER!**

The ground wire must always be connected before connecting the power supply to the mains!

After connecting the ground wire, the neutral and line wires can be connected.

⇒ Once the connections have been made, the upstream circuit-breaker can be closed. To complete the installation, the Status LED must be verified to be green.

**Communication:**

The two Ethernet ports (top left) are used to connect a computer and/or an external controller. The communication speed is 10 / 100 Mbps.

For an easier identification, each port is numbered (see symbols in Figure 8.2 or on the product).

## 9. Commissioning

Before starting to commission the power supply, check that the status LED (“UPS DC Status”) is green. This means the product is powered properly and ready to function.

The communication parameters can be configured via the HTTPS website. It also makes it possible to configure the energy saving mode (ECO) and the stealth mode.

In order to communicate with the product, it must be configured according to the following chapters. The computer’s network configuration, to which the product will be connected to, has to be compatible with the product’s network parameters.

### 9.1 Communication protocols

The product supports the following communication protocols. They can operate simultaneously. It is therefore not necessary to select a single active protocol.

#### Application layer protocols

- HTTPS
- BACnet IP
- SNMP v1, v2c + v3
- DHCP

#### Network layer protocols

- IPv4
- ICMP

### 9.2 Installing the root certificate

To use the products in HTTPS and to communicate safely with them the SLAT root certificate must be installed on the user's computer. This certificate is valid for all SLAT products and can be downloaded from the Library Account on the [www.slat.com/en/download](http://www.slat.com/en/download) website.

The **root certificate** is named **SLAT\_ca\_cert.crt**

The certificate must be installed in the certificate store: "Trusted Root Certification Authorities"

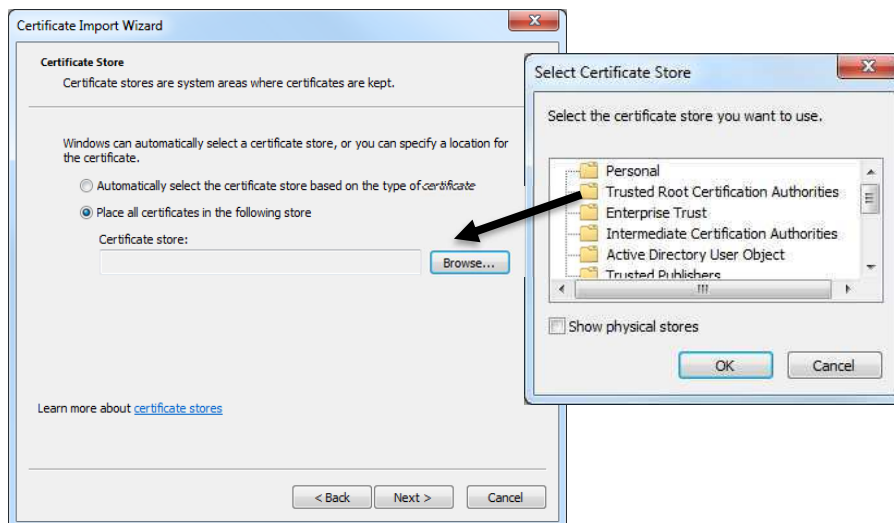

Figure 9.1: Selecting the certificate store

### 9.3 Assigning an IP address

The DHCP (dynamic IP address allocation) automatically assigns an IP address to a product in order to communicate with it. This feature is enabled by default in the factory configuration.

Two different operating modes exist according to the availability or lack of a DHCP server on the network:

A. DHCP server available

If a DHCP server is available, it automatically allocates an IP address to the product. If several products are connected to the network, it assigns a different IP address to each one.

To determine the new address, browse the network

B. DHCP server not available

If no DHCP server is available on the network, the product uses the IP settings below. When the product is first connected to the network, it remains in DHCP for 1 minute before switching to the predefined IP address:

- IP address **192.168.1.1**
- Network mask **255.255.255.0**
- No gateway

In this case, if several products need to be connected to a single network, as they possess the same IP parameters, they must be isolated and the IP address of each product must be modified using their HTTPS web interface before being connected to the network in order to avoid any address conflict. The same procedure applies if the same IP address exists several times on a given network. See chapter 9.6. for instructions on changing the IP address.

### 9.4 Login page – Logging onto the product

Using the allocated or predefined IP address, it is possible to log onto the product using a web browser (over HTTPS). The language used is that of the web browser.

---

**IMPORTANT REMARK!**



The default login and password are:

**Login: admin**

***There is no password. Click directly on "OK".***

**For the security of your installation, it is imperative to set a password!**

---

Once connection with the product has been established, the "SYSTEM STATE" page is displayed (see chapter 9.8). If there is no password, the "CONFIGURATION" page (see chapter 9.5) opens and a message indicates that it must be set. The default language of the administrator's embedded web site is English.



Figure 9.2: Login page

## 9.5 Configuration page – General settings' configuration

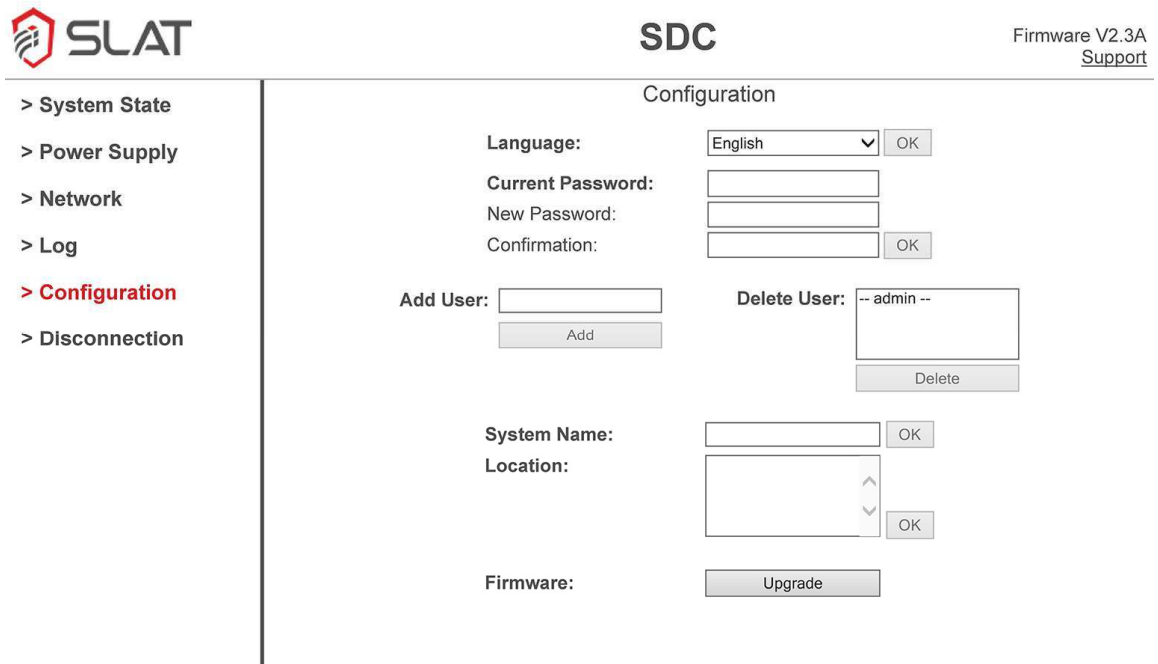

Figure 9.3: Configuration page

To configure the product, click on the "CONFIGURATION" tab in the left-hand menu. This page allows to perform the following configuration operations (see also Figure 9.3). Confirm the operations by clicking on the button next to them ("OK", "Add", "Delete", "Update").

1. **Change language**
2. **Change password**
3. **Add user**

Up to 8 users (including the administrator) can be created. By default, the user account is created in the same language as that of the administrator. It can be changed as required.

A new user does not need to enter a password. Upon initial logon, he/she will be prompted to set a password from the "CONFIGURATION" page.

4. **Delete user**
5. **Enter the system name**

The system name with up to 16 characters can be entered. Over HTTPS, the name always possesses the prefix "SDC-". This information is also available over SNMP and BACnet IP, but without the prefix.

6. **Enter the product location**

The location here defined is shown on the "SYSTEM STATE" page (see chapter 9.8). This information is also available over SNMP and BACnet IP.

7. **Updating Firmware (communication)**

The communication firmware can be updated to install new functions. The current version is displayed in the top right-hand corner of the page.

Operations 1 and 2 can be performed from all accounts (administrator and users). Operations 3 to 7 however, can only be performed by the administrator.

## 9.6 Network page – IP connection and Ethernet information configuration

SLAT SDC Firmware V2.3A Support

> System State  
> Power Supply  
**> Network**  
> Log  
> Configuration  
> Disconnection

Network

Port	Link	IP Address	
Port1 -	100Mb/s	0.0.0.0	OK
Port2 -	-	0.0.0.0	OK

Update

Green Ethernet (EEE):  OK

DHCP:

System IP Address: 192.168.1.1

Network Mask: 255.255.255.0

Gateway IP Address: 0.0.0.0 OK

NTP Server IP Address #1: 10.1.3.35

NTP Server IP Address #2: 0.0.0.0

System Timezone Offset (minutes): 51 OK

BACnet: Read/Write OK

SNMP: V3 - Read/Write

USM User: utilisateur

Auth Algorithm: SHA224

Auth Password:

Privacy Algorithm: AES-128-CFB

Privacy Password:

SNMP Server IP Address #1: 0.0.0.0 OK

SNMP Server IP Address #2: 0.0.0.0 OK

[SNMP MIB Download](#)

Figure 9.4: Network page

To configure the IP connection, click on the "NETWORK" tab in the left-hand menu. This page displays all connection-related information (e.g.: connected ports, IP address).

The administrator can access and edit all information.

Users can only view the information concerning each port (1) and the product's IP parameters (3).

### 1. Port configuration

The table shows the configuration and status of each of the two ports on the SDC-M IP.

To save changes made to a port, click on "OK" to the right of the same row.

- Port**  
 This column contains the port identifier. It can be customized as required by entering a name of up to 11 characters in the right-hand box.  
 If an IP address has been entered in the "IP Address" column, then the text "Port X" is a hypertext link to this same IP address.
- Link**  
 This column indicates whether an Ethernet link has been established, displaying the connection speed (10 or 100 Mbps).
- IP Address**  
 This field is used to enter an IP address. If this IP address is different from "0.0.0.0", it changes the "Port X" identifier to a hypertext link to this same IP address.

### Updating the information

The data are automatically refreshed every 10 seconds, except when an edit operation is in progress. By clicking on "Update", the data can be manually refreshed.

## 2. Green Ethernet configuration (EEE – Energy-Efficient Ethernet)

The Green Ethernet function allows to reduce automatically the power consumption of an Ethernet link depending to its usage. To save the configuration of the Green Ethernet, checked the box and click on « OK » to the right on the same line.

Some incompatibilities can cause instability of the Ethernet link. In this case, it is recommended to disable the Green Ethernet.

## 3. Product IP parameter configuration

The product's IP parameters consist of its IP address, network mask and gateway IP address. These parameters can be automatically assigned by DHCP or entered manually. DHCP is enabled by default. It is only possible to function in DHCP if a DHCP server is available on the network.

The following paragraph explains how to change the product's IP parameters:

- Automatic IP parameter assignment

For an automatic assignment, the DHCP must be enabled (box to the right of DHCP checked). Click on "OK" next to "Gateway IP Address". The DHCP server allocates a new IP address to the product. It is necessary to explore the network to know the new address.

- Manually entering IP parameters

To enter the IP parameters manually, DHCP must be disabled (box to the right of DHCP unchecked). Enter the new parameters into the three fields below (product IP address, network mask and gateway IP address). If the gateway feature is to be disabled, enter the gateway IP address of "0.0.0.0". Click on "OK" next to "Gateway IP Address" to save the configuration. The user is automatically re-routed to the new address (login page).

## 4. NTP configuration

The NTP servers (Network Time Protocol) are used to synchronize the system clock. It is necessary to:

- Enter the IP address of one or two NTP Servers, in order to obtain the UTC time.
- Enter the offset in minutes between the system time zone and the UTC time, to correctly date events. The value range in minutes is from -720 to +720, which allows all time zones to be covered.
- To save the settings, press «OK» on the right of the «System Timezone Offset» line.

## 5. BACnet IP protocol configuration

The BACnet IP protocol can operate in one of the following modes:

- Read/Write  
The data can be viewed and modified via the BACnet IP protocol. Actions can be implemented.
- Read Only (default mode)  
The data can only be viewed via the BACnet IP protocol.
- Disabled  
The BACnet IP protocol is disabled.

Click on "OK" next to "BACnet" to save the configuration.

## 6. SNMP protocol configuration

The product supports SNMP versions V1, V2c and V3. The SNMP protocol can operate in one of the following modes:

- Read/Write  
The data can be viewed and modified via the SNMP protocol. Actions can be implemented.
- Read Only (default mode)  
The data can only be viewed via the SNMP protocol.
- Disabled  
The SNMP protocol is disabled.

Version SNMP V1 and V2c: click on "OK" next to "SNMP" to save the configuration.

Version SNMP V3:

- USM User  
Create a login.
- Auth Algorithm  
Choose the algorithm to hash the password corresponding to the login.
- Auth Password  
Enter a password of between 8 and 16 characters.
- Privacy Algorithm  
Choose the encryption algorithm.
- Privacy Password  
Enter an encryption code of between 8 and 16 characters.

Click on "OK" next to "Privacy Password " to save the configuration.

If the user wishes to receive SNMP traps, he/she must configure the IP address of the SNMP servers receiving them. To save the changes, click on "OK" to the right of the same row.

If the function is to be disabled, enter the IP address of "0.0.0.0".

Two SNMP servers can be entered.

## 7. Loading the MIB

The SNMP MIB (Management Information Base) can be downloaded via the hypertext link. In case the download does not start, verify that it is not blocked by the Internet browser.

## 9.7 Power Supply page – Power supply configuration

The "POWER SUPPLY" page contains information about the battery and its use. Only the administrator is authorized to edit this information. Users can only view them.

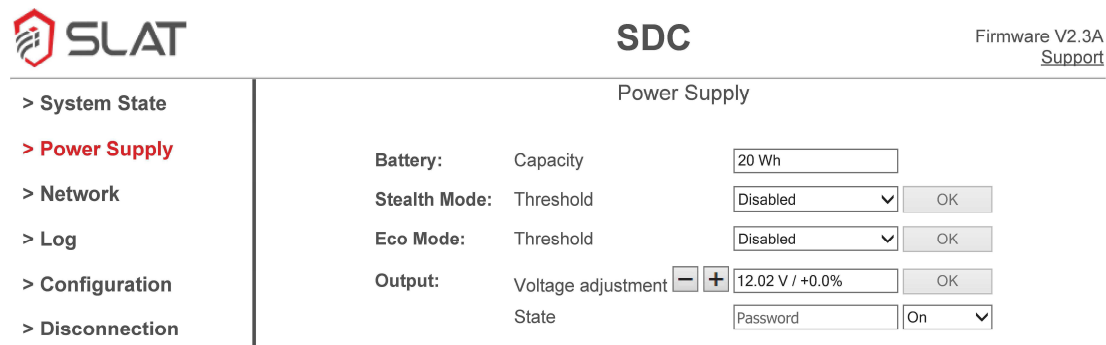

The screenshot shows the SLAT SDC interface for the Power Supply configuration page. The top left features the SLAT logo, and the top right shows 'SDC' and 'Firmware V2.3A Support'. A sidebar on the left lists navigation options: > System State, > Power Supply (highlighted in red), > Network, > Log, > Configuration, and > Disconnection. The main content area is titled 'Power Supply' and contains the following settings:

- Battery:** Capacity is set to 20 Wh.
- Stealth Mode:** Threshold is set to Disabled with an OK button.
- Eco Mode:** Threshold is set to Disabled with an OK button.
- Output:** Voltage adjustment is set to 12.02 V / +0.0% with minus and plus buttons and an OK button. The State is set to Password with an On dropdown menu.

Figure 9.5: Power Supply page

### Battery

The capacity displayed is the battery's minimum capacity. The value is given for information purposes and cannot be changed. It differs from the typical capacity value given on the product label

### Stealth Mode

The Stealth Mode allows supervision to stop the product consumption to relieve network load. The product automatically pass in normal operation once the remaining autonomy has reached the guaranteed autonomy percentage selected by the administrator during configuration.

To enable the Stealth Mode, the threshold (percentage of the guaranteed autonomy when Stealth Mode is used) must be defined: 25% / 50% / 75% / Disabled. Click on "OK" to the right to save the new threshold.

### Eco Mode

When enabled, the Eco Mode improves power efficiency at low load (<20% of  $I_{max}$ ), while guaranteeing a defined percentage of autonomy. In the factory settings, the Eco Mode is disabled by default.

To enable the Eco Mode, the threshold (percentage of the autonomy that must remain available to the user) must be defined: 50% / 60% / 70% / 80% / Disabled. Click on "OK" to the right to save the new threshold.

### Output

The factory setting of the output voltage is  $U_n$ . This value can be adjusted via the HTTPS website to notably compensate for losses due to cable lengths. The value can vary from -8% to +13% of  $U_n$ .

The voltage is adjusted using the "+" and "-" buttons. Adjustment is made in 0.1% increments, accelerating when the button is held. Click on "OK" to the right to save the changes.

To modify the power supply output status (stop, start or restart), enter the password and select the desired status. The status changes and the "System state" page updates automatically.

## 9.8 System State page – Access to system information

Once connection with the product has been established, the "SYSTEM STATE" page is displayed. Figure 9.6 and the following paragraph describe the information displayed on this page.

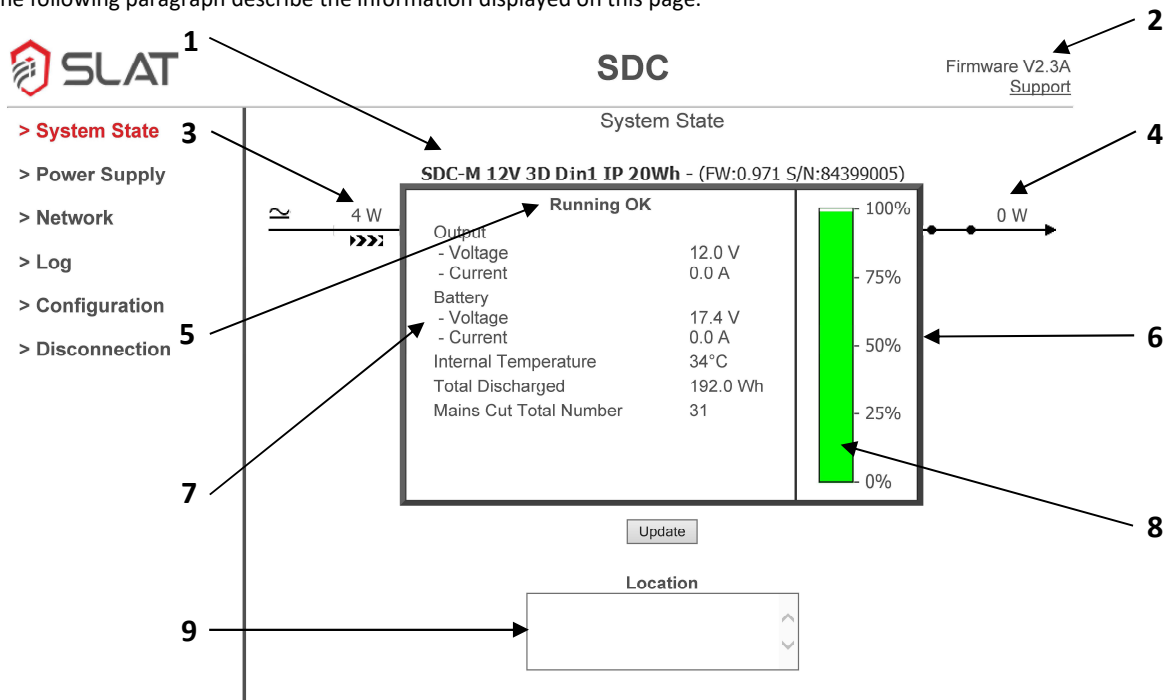

Figure 9.6: System State page

The "System State" page displays the operating status and all the physical values measured by the product. It is refreshed every 10 seconds. To manually refresh the data, click on "Update".

### 1. Product description

- Reference and version
- Minimum capacity in Watt-hour
- Power supply firmware version and serial number

### 2. Communication firmware version and support

You can use the "Support" link to send an email to SLAT's after-sales service.

### 3. Mains input

Mains power is indicated by the pictogram on the left in Figure 9.6. If no mains power is present, a red cross is displayed over the pictogram. The value displayed indicates mains consumption in Watts.

### 4. Output

When the switch is closed, the application is powered by the product. If the switch is open, the backup is reaching the end of its autonomy: disconnection and interruption of the power supply are imminent. The value indicates the total power supplied to the user in Watts.

### 5. Product operating status

The text indicates whether product operation is ok, or whether there is a product fault

### 6. Operating mode

The product operating mode is indicated by the frame color:

- Operating on mains                      gray frame
- Operating on backup                    orange frame
- Eco or Stealth Mode                    green frame

**7. Operation-related data**

- Output current and voltage
- Battery voltage and current  
If the displayed battery current is negative, the battery is discharging.
- Safe DC's internal temperature
- Total Watt-hours drained from the Safe DC since product factory inspection and commissioning
- Total number of mains cuts since product factory inspection and commissioning

**8. Charge gauge**

The gauge shows the backup pack's charge status. The backup pack must be fully charged once before the gauge will display an accurate reading.

**9. Location**

The location defines the place where the product is installed. This information can be changed in the "CONFIGURATION" page (see chapter 9.5).

**9.9 Log page – Access to event log**

To access the event log, click on the «Log» heading in the menu on the left. On this page the event history is displayed. It can be filtered in four categories: power, network, configuration and miscellaneous. The history can contain up to 100 events, the oldest being deleted automatically. The filtered event list can be downloaded as text.

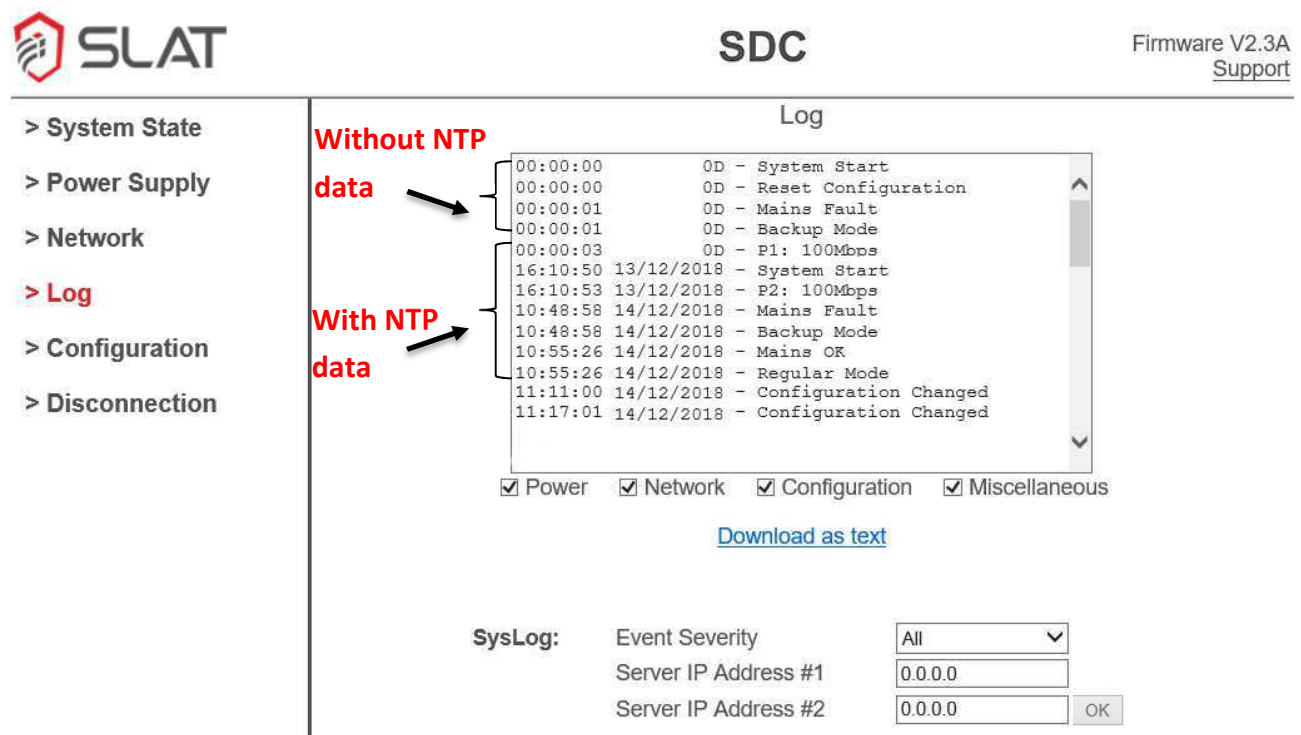

The screenshot shows the SLAT SDC interface with the 'Log' menu item selected. The event log is displayed with a scrollable list of events. Annotations in red text with arrows point to specific rows: 'Without NTP data' points to the first four rows (00:00:00 to 00:00:03), and 'With NTP data' points to the subsequent rows (16:10:50 to 11:17:01). Below the log, there are checkboxes for 'Power', 'Network', 'Configuration', and 'Miscellaneous', all of which are checked. A 'Download as text' link is present. At the bottom, there is a 'SysLog' section with fields for 'Event Severity' (set to 'All'), 'Server IP Address #1' (0.0.0.0), and 'Server IP Address #2' (0.0.0.0), along with an 'OK' button.

Figure 9.7: Log page

**1. Time stamp**

If the date and time are available via the NTP (see 4. NTP configuration, page 18), then the events are time stamped in the following format:

```

hours : minutes : seconds   day/month/year 16:10:50 13/12/2018 - System Start
16:10:53 13/12/2018 - P2: 100Mbps
Example ↻ 10:48:58 14/12/2018 - Mains Fault
10:48:58 14/12/2018 - Backup Mode
10:55:26 14/12/2018 - Mains OK
    
```

Otherwise, the elapsed time since the last start is used pending the availability of NTP data. In this case, the events are in the following format:

```

hours : minutes : seconds   the number of the days D 00:00:00          0D - System Start
00:00:00          0D - Reset Configuration
Example ↻ 00:00:01          0D - Mains Fault
00:00:01          0D - Backup Mode
00:00:03          0D - P1: 100Mbps
    
```

**2. Syslog**

The product is able to send events via UDP / 514 to one or two syslog servers (RFC 5424 and RFC 5426). Enter the level of severity of the events to be sent and the IP address (es) of the servers.

LEVEL	DESCRIPTION	EVENT SEVERITY				
		ALL	< 5	< 4	DISABLED	
0	Emergency	System is unusable.	✓	✓	✓	
1	Alert	Action must be taken immediately if necessary	✓	✓	✓	
2	Critical	Critical conditions. for the system	✓	✓	✓	
3	Error	Operating error	✓	✓	✓	
4	Warning	Warning (An error can occur if no action is taken)	✓	✓		
5	Notice	Normal but significant conditions	✓			
6	Informational	Informational message	✓			

The category code used for the priority of SysLog messages is 1.

### 3. List of events

TYPE OF EVENTS	LEVEL OF SEVERITY	COMMENT
End of backup	0	Backup at the end of autonomy. Imminent stop.
Short Circuit	2	Short-circuit at output.
Charger Fault	2	Charger malfunction: the product needs to be changed.
Converter Fault	2	Converter malfunction: the product must be changed.
Battery Fault	2	Battery malfunction: the product must be changed.
Backup Mode	4	The product operates in Backup out of Green mode.
Overload	4	Output consumption > 100% of the nominal value (current limitation to limit the output power).
Mains Fault	4	No mains.
Temperature Fault	4	Internal temperature too high.
High Consumption	5	Output consumption > 95% of the nominal value.
Regular Mode	6	Normal operation on mains.
Green Mode	6	Mains present, the product is in Stealth Mode or Energy Saving Mode (ECO)
Consumption OK	6	Normal output consumption.
Stealth Request	6	Receiving an external setpoint to operate in Stealth Mode
Stop Stealth Request	6	Receiving an external setpoint to stop the Stealth Mode.
Mains OK	6	The mains is present.
Temperature OK	6	Internal temperature OK.
Charger OK	6	Proper operation of the charger.
Converter OK	6	Correct operation of the output converter.
Battery OK	6	Battery OK.
Output Off	6	Output converter stop command.
Output On	6	Output converter run command.
Output Restart	6	Output converter restart command (stop for 8 seconds).

Table 9.1: Events related to the power converter

TYPE OF EVENTS	LEVEL OF SEVERITY	COMMENT
Link Fault	4	Event enabled when disconnecting a port or losing an Ethernet link. The event is active until it is acknowledged (See Table 10.3: Detail of the "System state" variable- Bit 26 - Ethernet failure)
Link Fault Acknowledged	6	Acknowledgment of the event «Link Fault».
P* - No link	6	Ethernet link state of the port P*
P* - 10 Mbps	6	
P* - 100 Mbps	6	

P\* → Port 1 and 2

Table 9.2: Events related to the network

TYPE OF EVENTS	LEVEL OF SEVERITY	COMMENT
Reset Configuration	5	Reset the factory configuration (see 9-10, page 25).
Configuration Changed	6	Event generated 2 minutes after the last configuration change of the product.

Table 9.3: Events related to the configuration

TYPE OF EVENTS	LEVEL OF SEVERITY	COMMENT
System Start	5	Generated when starting or rebooting the system.

Table 9.4: Events related to the system

## 9.10 Factory configuration reset

In order to return to the original settings, a factory configuration reset has to be performed by pressing and holding the disconnect backup push button for 10 seconds, with mains power present (see Figure 6.2). The factory configuration reset concerns all user-definable parameters, including DHCP. The total Watt-hours drained and the number of mains cuts, displayed on the "System State" page (see chapter 0) are not reset.



### **IMPORTANT REMARK!**

To perform the factory configuration reset, the product must be connected to the mains, or it will be switched off.

## 9.11 Product switch-off

To stop and switch-off the product, it is necessary to:

- Disconnect the mains power
- Press the disconnect backup push button (see Figure 6.2)

## 10. Operation

During use, it is possible to interact with the product. There are two types of communication: local report and/or remote report.

### 10.1 Local report on product

#### Status LED (*UPS DC Status*)

The product communicates its status via a Status LED on the front. Figure 6.2 in chapter 6.4 indicates the position of this LED on the product. The LED indicates the different states of the product by its color and state. The table explains the meanings of each state.

Color		State
Green	steady	Normal mode
	slow flashing	Eco Mode or Stealth Mode
Orange	slow flashing	Backup mode
	fast flashing	Installation fault
		Overcurrent, short circuit
		Low output voltage (product overloaded)
		Power supply temperature too high
		No mains (outside specified power supply range)
End of backup imminent		
Red	steady	UPS to be changed
		If no output voltage
		If power supply out of order (charger fault)
		Backup fault
		Emergency supply undervoltage
		Emergency supply overvoltage

Table 10.1: Status LED state

#### Ethernet LED (*Link/Act*)

The product indicates its communication status via the front panel LEDs. One LED indicates the status and activity for each Ethernet connection.

Figure 6.2 in chapter 6.4 indicates the position of these LEDs on the product. The state of the LEDs indicates the different connection statuses. The table describes the meaning of each state.

Color		State
Green	steady	Connection established
	flashing	Connection established and activity on the line

Table 10.2: Ethernet LED state

## 10.2 Remote report – Communication

When using the product, it is possible to communicate with it from a distance using the incorporated communication system. The Ethernet connection enables to:

- retrieve information remotely,
- have more details about the types of faults,
- communicate analogue values (operating voltages and currents, remaining backup percentage, internal temperature, autonomy),
- configure the power supply.

The product communicates its information through the Ethernet connection via the HTTPS, SNMP and BACnet IP application protocols.

The information and explanations on how to configure the product are described in chapter 9.

The following chapters describe the information available via the different protocols.

### 10.2.1 Accessible data

The following data are available via SNMP and BACnet IP.

Bit	Name	Description
27 - 31	- Reserved -	-
26	Ethernet Failure	In read mode, if the bit is set to 1, then one or more Ethernet links have been lost. The fault remains active even if the links are restored. To acknowledge the fault, set bit to 1, which then switches to 0 in read mode.
25	Halt Stealth	Set bit to 1 to stop Stealth Mode. This bit is always read as 0.
24	Start Stealth / Stealth State	In read mode, if the bit is set to 1, then Stealth Mode is running. Set bit to 1 to start Stealth Mode.
20 - 23	- Reserved -	-
19	Communication Failure	Internal communication failure if the bit is 1. The values of the read data are not significant.
18	Initialization Failure	Initialization of the internal communication in progress if the bit is 1. The values of the read data are not significant.
16 - 17	- Reserved -	-
15	High Battery Current	If the bit is set to 1, then the battery current is too high.
14	High Battery Voltage	If the bit is set to 1, the product must be replaced: the battery voltage is too high.
13	End of Autonomy	End of autonomy pre-alarm when the bit is set to 1 (imminent cut).
12	Battery Failure	If the bit is set to 1, the product must be replaced: the battery is defective or has been removed.
11	Rectifier Failure	If the bit is set to 1, the product must be replaced: the charging system is faulty, and the battery may not be charged.
10	Mains Failure	If the bit is set to 1, mains power is absent.
9	Output Overload	If the bit is set to 1, the output is overloaded.
8	Output Short-Circuit	If the bit is set to 1, the output is short-circuited.
7	High Temperature	If the bit is set to 1, the temperature in the product is too high.
6	Battery Disconnection	If the bit is set to 1, the battery is disconnected.
5	Stealth Mode or Eco Mode	If the bit is set to 1, then Stealth Mode or Eco Mode is enabled.
4	Intrusion Detection	When the option is present, if the bit is set to 1, then the box tampering and tearing detection is enabled.
0 - 3	- Reserved -	-

Table 10.3: Detail of the "System state" variable

Bit	Name	Description										
26 - 31	- Reserved -	-										
24 - 25	Ethernet State	Ethernet port status: <table border="1" data-bbox="762 1771 1295 1928"> <thead> <tr> <th>Value</th> <th>Status</th> </tr> </thead> <tbody> <tr> <td>00</td> <td>No link</td> </tr> <tr> <td>01</td> <td>10 Mbps link</td> </tr> <tr> <td>10</td> <td>100 Mbps link</td> </tr> <tr> <td>11</td> <td>1000 Mbps link</td> </tr> </tbody> </table>	Value	Status	00	No link	01	10 Mbps link	10	100 Mbps link	11	1000 Mbps link
Value	Status											
00	No link											
01	10 Mbps link											
10	100 Mbps link											
11	1000 Mbps link											
0 - 23	- Reserved -	-										

Table 10.4: Detail of the "Ethernet port X state" variable

### 10.2.2 HTTPS Protocol

The HTTPS website provides product management and data processing-related information.

Chapter 9 describes the use of the HTTPS website and the various data available.

To log onto the embedded website, use the selected login and password. Chapter 9.5 explains how to change the password.

### 10.2.3 SNMP Protocol

2 MIBs are available over SNMP:

- The **MIB-2**, defined by the RFC1213 standard.
- The **MIB SLAT-SDC** is proprietary and specific to SLAT. It is common to the entire Safe DC range. It can be downloaded from the embedded website (HTTPS) on the "Network" page (see chapter 9.6).



**IMPORTANT REMARK!**

For the SNMP v1 et v2c the Write Community is "private".

For the SNMP v3 the user and the password must be configured.

The following variables are available via SNMP:

<u>Mib-2</u>		
Variable	SNMP Name	Description
Model	sysDesc	SDC reference and version.
System name	sysName	SDC system name (available in write mode, up to 16 characters)
Location	sysLocation	SDC location (available in write mode, up to 32 characters)

Table 10.5: MIB-2 variables

<b>Mib SLAT</b>		
<b>Variable</b>	<b>SNMP Name</b>	<b>Description</b>
Model	model	SDC reference and version.
Capacity	capacity	Battery capacity: energy expressed in Watts-hours.
Serial number	serialNumber	SDC serial number.
System state	systemState	32-bit variable presenting the state of the SDC system. Each time a change is made, this variable is sent in the form of an SNMP trap (for details of the variable, see Table 10.3) *.
Gauge	energyGauge	Gauge in percent, corresponding to the amount of energy available in the battery. A value of 100 corresponds to a fully charged battery.
Output voltage	outputVoltage	Output voltage: the value is expressed in tenths of a Volt.
Output current:	outputCurrent	Output current: the value is expressed in tenths of an Ampere.
Output power	outputPower	Instantaneous power supplied by the SDC: the value is expressed in Watts.
Mains power	mainsPower	Instantaneous mains power input: the value is expressed in Watts.
Temperature	temperature	SDC internal temperature: the value is expressed in °C.
Total discharged energy	totalDischargedEnergy	Amount of energy provided by the SDC battery since initial commissioning: the value is expressed in tenths of a Watt-hour.
Mains cut total number	mainsCutTotalNumber	Total number of mains cuts since initial commissioning.
Output voltage adjustment	voutAdjust	Output voltage adjustment value. This value must be between 0 and 4095 for a variation in rate voltage of between -8% and +13% approximately. The value 1536 corresponds to the rated voltage.
Stealth Mode threshold	stealthModeThreshold	Minimum battery charge level in percent for Stealth Mode. Accepted values: 25, 50, 75 or 100. The value 100 disables the Stealth Mode.
Eco Mode threshold	ecoModeThreshold	Minimum battery charge level in percent for Eco Mode. Accepted values: 50, 60, 70, 80 or 100. The value 100 disables Eco Mode.
Ethernet port X state	EthernetPortX-State	32-bit variable presenting the status of each Ethernet port, X representing the port number (for details of this variable, see Table 10.4).

Table 10.6: MIB SLAT variables

\* To use SNMP traps, the IP addresses of the SNMP servers to which the traps should be sent must be entered into the HTTPS website (see chapter 9.6).

## 10.2.4 BACnet IP Protocol

The following objects are accessible via BACnet IP:

Property	Remark / Value	RW
Object_Identifier	Product instance, by default: 421000	RW-E
Object_Name	SDC system name (max. 16 characters). By default: ""	RW-E
Object_Type	DEVICE (8)	R
System_Status	OPERATIONAL (0) or STATUS_NON_OPERATIONAL (4) if not ready	R
Vendor_Name	"SLAT"	R
Vendor_Identifier	954	R
Model_Name	Product type	R
Location	Product location (max. 32 characters). By default: ""	RW-E
Firmware_Revision	Communication firmware version	R
Application_Software_Version	""	R
Protocol_Version	1	R
Protocol_Revision	12	R
Protocol_Services_Supported	read-property, write-property, who-has, who-is, device-communication control	R
Protocol_Object_Types_Supported	DEVICE, ANALOG_VALUE, POSITIVE_INTEGER_VALUE	R
Object_List [17]	device, analog-value 0 ...10, positive_integer_value 0...4	R
Max_APDU_Length_Accepted	1476	R
Segmentation_Supported	NO_SEGMENTATION (3)	R
APDU_Timeout	3000	R
Number_Of_APDU_Retries	3	R
Device_Address_Binding	-	R
Database_Revision	0	R
Serial_Number	Serial number	R
R: Read Property, W: Write Property, -E: Storage in EEPROM / Flash		

Table 10.7: BACnet IP variables

Analog Value Object 0		
Property	Remark / Value	RW
Object_Identifier	analog-value 0	R
Object_Name	"Vout"	R
Object_Type	ANALOG_VALUE (2)	R
Description	"Output Voltage"	R
Present_Value	Output Voltage	R
Status_Flags	IN_ALARM: 0	R
	FAULT: 0	
	OVERRIDDEN: 0	
	OUT_OF_SERVICE: 0	
Event_State	NORMAL (0)	R
Out_Of_Service	FALSE (0)	R
Units	Volts (5)	R
R: Read Property, W: Write Property, -E: Storage in EEPROM / Flash		

Table 10.8: Analog Value Object 0

Analog Value Object 1		
Property	Remark / Value	RW
Object_Identifier	analog-value 1	R
Object_Name	"Iout"	R
Object_Type	ANALOG_VALUE (2)	R
Description	"Output current"	R
Present_Value	Output current	R
Status_Flags	IN_ALARM: 0	R
	FAULT: 0	
	OVERRIDDEN: 0	
	OUT_OF_SERVICE: 0	
Event_State	NORMAL (0)	R
Out_Of_Service	FALSE (0)	R
Units	Amperes (3)	R
R: Read Property, W: Write Property, -E: Storage in EEPROM / Flash		

Table 10.9: Analog Value Object 1

Analog Value Object 2		
Property	Remark / Value	RW
Object_Identifier	analog-value 2	R
Object_Name	"Pout"	R
Object_Type	ANALOG_VALUE (2)	R
Description	"Output power"	R
Present_Value	Output power	R
Status_Flags	IN_ALARM: 0	R
	FAULT: 0	
	OVERRIDDEN: 0	
	OUT_OF_SERVICE: 0	
Event_State	NORMAL (0)	R
Out_Of_Service	FALSE (0)	R
Units	Watts (47)	R
R: Read Property, W: Write Property, -E: Storage in EEPROM / Flash		

Table 10.10: Analog Value Object 2

Analog Value Object 3		
Property	Remark / Value	RW
Object_Identifier	analog-value 3	R
Object_Name	"Pin"	R
Object_Type	ANALOG_VALUE (2)	R
Description	"Input power"	R
Present_Value	Mains power	R
Status_Flags	IN_ALARM: 0	R
	FAULT: 0	
	OVERRIDDEN: 0	
	OUT_OF_SERVICE: 0	
Event_State	NORMAL (0)	R
Out_Of_Service	FALSE (0)	R
Units	Watts (47)	R
R: Read Property, W: Write Property, -E: Storage in EEPROM / Flash		

Table 10.11: Analog Value Object 3

Analog Value Object 4		
Property	Remark / Value	RW
Object_Identifier	analog-value 4	R
Object_Name	"Temperature"	R
Object_Type	ANALOG_VALUE (2)	R
Description	"Internal temperature"	R
Present_Value	Internal temperature	R
Status_Flags	IN_ALARM: 0	R
	FAULT: 0	
	OVERRIDDEN: 0	
	OUT_OF_SERVICE: 0	
Event_State	NORMAL (0)	R
Out_Of_Service	FALSE (0)	R
Units	Degree Celsius (62)	R
R: Read Property, W: Write Property, -E: Storage in EEPROM / Flash		

Table 10.12: Analog Value Object 4

Analog Value Object 5		
Property	Remark / Value	RW
Object_Identifier	analog-value 5	R
Object_Name	"BatteryGauge"	R
Object_Type	ANALOG_VALUE (2)	R
Description	"Remaining autonomy"	R
Present_Value	Battery gauge	R
Status_Flags	IN_ALARM: 0	R
	FAULT: 0	
	OVERRIDDEN: 0	
	OUT_OF_SERVICE: 0	
Event_State	NORMAL (0)	R
Out_Of_Service	FALSE (0)	R
Units	Percent (98)	R
R: Read Property, W: Write Property, -E: Storage in EEPROM / Flash		

Table 10.13: Analog Value Object 5

Analog Value Object 6		
Property	Remark / Value	RW
Object_Identifier	analog-value 6	R
Object_Name	"Battery capacity"	R
Object_Type	ANALOG_VALUE (2)	R
Description	"Installed battery capacity"	R
Present_Value	Battery capacity	R
Status_Flags	IN_ALARM: 0	R
	FAULT: 0	
	OVERRIDDEN: 0	
	OUT_OF_SERVICE: 0	
Event_State	NORMAL (0)	R
Out_Of_Service	FALSE (0)	R
Units	Watt hours (18)	R
R: Read Property, W: Write Property, -E: Storage in EEPROM / Flash		

Table 10.14: Analog Value Object 6

Analog Value Object 7		
Property	Remark / Value	RW
Object_Identifier	analog-value 7	R
Object_Name	"StealthModeThreshold"	R
Object_Type	ANALOG_VALUE (2)	R
Description	"Minimum battery gauge level for Stealth Mode (25%, 50% or 75% - 100 disables Stealth Mode)"	R
Present_Value	Stealth Mode threshold	R
Status_Flags	IN_ALARM: 0	R
	FAULT: 0	
	OVERRIDDEN: 0	
	OUT_OF_SERVICE: 0	
Event_State	NORMAL (0)	R
Out_Of_Service	FALSE (0)	R
Units	Percent (98)	R
R: Read Property, W: Write Property, -E: Storage in EEPROM / Flash		

Table 10.15: Analog Value Object 7

Analog Value Object 8		
Property	Remark / Value	RW
Object_Identifier	analog-value 8	R
Object_Name	"EcoModeThreshold"	R
Object_Type	ANALOG_VALUE (2)	R
Description	"Minimum battery gauge level for Eco Mode (50%, 60%, 70% or 80% - 100% disables Eco Mode)"	R
Present_Value	Eco Mode threshold	R
Status_Flags	IN_ALARM: 0	R
	FAULT: 0	
	OVERRIDDEN: 0	
	OUT_OF_SERVICE: 0	
Event_State	NORMAL (0)	R
Out_Of_Service	FALSE (0)	R
Units	Percent (98)	R
R: Read Property, W: Write Property, -E: Storage in EEPROM / Flash		

Table 10.16: Analog Value Object 8

Analog Value Object 9		
Property	Remark / Value	RW
Object_Identifier	analog-value 9	R
Object_Name	"TotalDischargedEnergy"	R
Object_Type	ANALOG_VALUE (2)	R
Description	"Total discharged energy"	R
Present_Value	Total discharged energy	R
Status_Flags	IN_ALARM: 0	R
	FAULT: 0	
	OVERRIDDEN: 0	
	OUT_OF_SERVICE: 0	
Event_State	NORMAL (0)	R
Out_Of_Service	FALSE (0)	R
Units	Watt hours (18)	R
R: Read Property, W: Write Property, -E: Storage in EEPROM / Flash		

Table 10.17: Analog Value Object 9

Analog Value Object 10		
Property	Remark / Value	RW
Object_Identifier	analog-value 10	R
Object_Name	"MainsCut"	R
Object_Type	ANALOG_VALUE (2)	R
Description	"Mains cut total number"	R
Present_Value	Total number of mains cuts	RW
Status_Flags	IN_ALARM: 0	R
	FAULT: 0	
	OVERRIDDEN: 0	
	OUT_OF_SERVICE: 0	
Event_State	NORMAL (0)	R
Out_Of_Service	FALSE (0)	R
Units	No units (95)	R
R: Read Property, W: Write Property, -E: Storage in EEPROM / Flash		

Table 10.18: Analog Value Object 10

Positive Integer Value Object 0		
Property	Remark / Value	RW
Object_Identifier	positive-integer-value 0	R
Object_Name	"Default"	R
Object_Type	POSITIVE_INTEGER_VALUE (48)	R
Description	"System state register"	R
Present_Value	System state [32 bit]*	R
Status_Flags	IN_ALARM: 0	R
	FAULT: 0	
	OVERRIDDEN: 0	
	OUT_OF_SERVICE: 0	
Units	No units (95)	R
R: Read Property, W: Write Property, -E: Storage in EEPROM / Flash		

Table 10.19: Positive Integer Value Object 0

\*To consult the detail of the "Present Value – System state" see Table 10.3.

Positive Integer Value Object 1		
Property	Remark / Value	RW
Object_Identifier	positive-integer-value 1	R
Object_Name	"StealthMode"	R
Object_Type	POSITIVE_INTEGER_VALUE (48)	R
Description	"Stealth mode operating"	R
Present_Value	Stealth Mode disabled if null, else enabled	RW
Status_Flags	IN_ALARM: 0	R
	FAULT: 0	
	OVERRIDDEN: 0	
	OUT_OF_SERVICE: 0	
Units	No units (95)	R
R: Read Property, W: Write Property, -E: Storage in EEPROM / Flash		

Table 10.20: Positive Integer Value Object 1

Positive Integer Value Object 2		
Property	Remark / Value	RW
Object_Identifier	positive-integer-value 2	R
Object_Name	"SerialNumber"	R
Object_Type	POSITIVE_INTEGER_VALUE (48)	R
Description	"Serial number"	R
Present_Value	Serial number	R
Status_Flags	IN_ALARM: 0	R
	FAULT: 0	
	OVERRIDDEN: 0	
	OUT_OF_SERVICE: 0	
Units	No units (95)	R
R: Read Property, W: Write Property, -E: Storage in EEPROM / Flash		

Table 10.21: Positive Integer Value Object 2

Positive Integer Value Object 3		
Property	Remark / Value	RW
Object_Identifier	positive-integer-value 3	R
Object_Name	"Ethernet1"	R
Object_Type	POSITIVE_INTEGER_VALUE (48)	R
Description	"1st Ethernet port state"	R
Present_Value	Port 1 status *	R
Status_Flags	IN_ALARM: 0	R
	FAULT: 0	
	OVERRIDDEN: 0	
	OUT_OF_SERVICE: 0	
Units	No units (95)	R
R: Read Property, W: Write Property, -E: Storage in EEPROM / Flash		

Table 10.22: Positive Integer Value Object 3

\*To consult the detail of the "Present Value - Port 1 status" see Table 10.4.

Positive Integer Value Object 4		
Property	Remark / Value	RW
Object_Identifier	positive-integer-value 4	R
Object_Name	"Ethernet2"	R
Object_Type	POSITIVE_INTEGER_VALUE (48)	R
Description	"2nd Ethernet port state"	R
Present_Value	Port 2 status *	R
Status_Flags	IN_ALARM: 0	R
	FAULT: 0	
	OVERRIDDEN: 0	
	OUT_OF_SERVICE: 0	
Units	No units (95)	R
R: Read Property, W: Write Property, -E: Storage in EEPROM / Flash		

Table 10.23: Positive Integer Value Object 4

To consult the detail of the "Present Value - Port 2 status" see Table 10.4.

## 11. Maintenance and troubleshooting

---

### Maintenance

The product has been designed to function for a long period of time without requiring maintenance. To ensure the best level of service, it is essential to install it in a dry dust-free location.



#### **IMPORTANT REMARK!**

For additional technical assistance, contact the SLAT hotline +33 4 78 66 63 70.

For an RMA request (authorization to return goods), refer to chapter 13.2 .

No equipment may be returned without prior issuance of an RMA number.

---



#### **DANGER!**

At no time should the box be opened, even for maintenance purposes.

---

For a proper functioning of the product, it is necessary to ensure that the ventilation grilles are dust-free.

## Troubleshooting

During installation, commissioning or use, unexpected situations may arise. In the event of a problem, the table below can be consulted. It contains a list of possible problems with their corresponding causes and solutions.

Problem	Fault via communication	Cause	Solution
The product does not start. The LED <i>UPS DC Status</i> remains off.	No communication	The mains voltage is not connected or is not present.	Check if the mains voltage is connected properly.
		The mains voltage fuse is faulty or absent.	Replace the product.
The LED <i>UPS DC Status</i> is orange + fast flashing and there is no voltage at the output.	Output short-circuit	Output overload or short-circuit.	Remove the short-circuit.
The LED <i>UPS DC Status</i> is red. The output voltage is OK.	Backup fault	Backup malfunction; the backup is disconnected or has failed.	Replace the product.
	Charger fault	Charger malfunction.	The charger has failed. Replace the product.
The LED <i>UPS DC Status</i> is orange + fast flashing and the output voltage is less than the normal value.	Output overload	There is a slight overload on the output.	Lower the output load until the current is less than the maximum output value (see Table 12.4).
The LED <i>UPS DC Status</i> is orange + fast flashing and the output voltage is OK.	Temperature too high	Temperature is too high because the ambient temperature does not fulfil the conditions specified in Table 12.7.	Cool the installation.
		The air intake is blocked.	Clean the blocked air intake.
The product's IP address is lost.	No communication	-	Perform a factory configuration reset (see chapter 9.10).
The administrator's password has been lost.	No communication	-	Perform a factory configuration reset (see chapter 9.10).
A user password has been lost.	No communication	-	Delete the account of the user via the administrator's account.
No connection: The Ethernet LED <i>Link/Act</i> of the port X is not illuminated.	No communication	Bad Ethernet connection.	Verify the connection and use an appropriate Ethernet cable (see Table 8.1).
The LEDs <i>UPS DC Status</i> and <i>Link/Act</i> are illuminated but there is no communication.	No communication	Configuration problem.	Check that the configuration of the SDC and the computer are compatible (see chapter 9).

Table 11.1: Problems, causes and solutions

## 12. Technical data

### 12.1 Electrical characteristics

#### 12.1.1 Electrical characteristics of the power supply

Mains input	
AC network voltage	99 V ... 264 V
DC network voltage	140 V ... 375 V
Frequency	45 Hz ... 65 Hz
Class	1
Inrush current	Limited by CTN
Neutral system	TT, TN, IT
Primary short-circuit protection	Slow-blow fuse on the phase
Characteristics of built-in fuse	2.5 A (slow-blow, internal)
Shock wave protection	Differential mode by varistor and filter
Primary current @ 99 V	1.5 A
Primary current @ 264 V	0.38 A
Residual consumption in Eco and Stealth Mode	< 1 W
Circuit breaker to be provided upstream	Curve C or D (recommended rating 2 A)

Table 12.1: Mains input electrical characteristics

#### Current behavior:

##### Inrush current at start-up

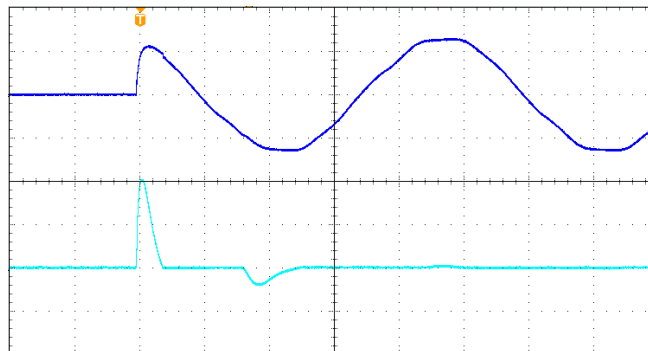

Figure 12.1: Oscillogram - inrush current

Test conditions	
Input voltage	240 V AC
Output current and voltage	12 V DC; no load
Ambient temperature	+20°C
Description of the diagram	
Upper curve	Input voltage (250 V / DIV)
Lower curve	Input current (20 A / DIV)
Time scale	4 ms / DIV

Table 12.2: Description of the oscillogram - inrush current

Start-up sequencing

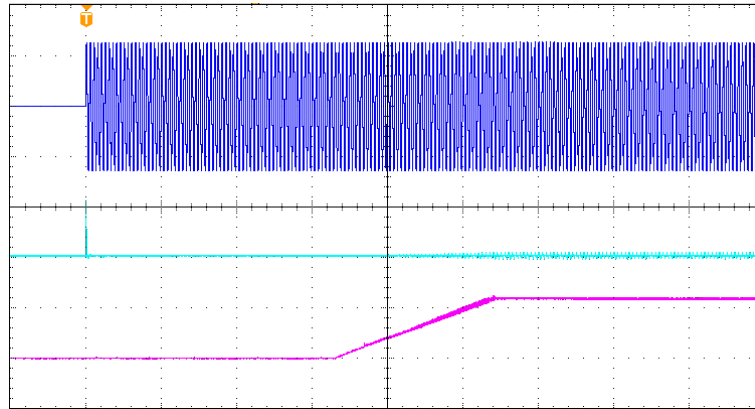

Figure 12.2: Oscillogram - starting behavior

Test conditions	
Input voltage	240 V AC
Output current and voltage	12 V DC; 4.5 A
Ambient temperature	+20°C
Description of the diagram	
Upper curve	Input voltage (250 V / DIV)
Medium curve	Input current (20 A / DIV)
Lower curve	Output voltage (10 V / DIV)
Time scale	400 ms / DIV

Table 12.3: Description of the oscillogram - starting behavior

### 12.1.2 Electrical output characteristics

Output		
One user output	constant DC voltage	
Rated voltage $U_n$	12 V	24 V
Rated output current $I_n$	4.6 A	2.3 A
Permissible peak currents	9 A / 12 ms	4.6 A / 8 ms
	23 A / 4 ms	11 A / 1.6 ms
Voltage precision	1%	
Available output power	55 W	
Adjustment via HTTPS (chapter 9.7 page 20) or SNMP (Table 10.6 page 29)	-8% ... +13%	
Power limitation	from $P_{max}$ to $P_{max}+10\%$ for output voltage > 6 V	
HF ripple peak-peak (20 MHz-50 $\Omega$ )	< 1.9% of $U_n$	
Effective LF ripple	< 0.3% of $U_n$	
Static and dynamic regulation characteristics	< 7% of $U_n$ for cumulative variations of the mains and the load (from 10 to 90%)	
Protection	electronic (no fuse)	
$\eta$ @ 20% of use load	90%	
$\eta$ @ 75% of use load	93%	
$\eta$ @ 100% of use load	92%	
Protection against output short-circuit	by power supply cut with cyclical restart	
Protection against surges in user output	deregulation or connection error, by cut-off with cyclical restart if output voltage > $U_n + 10\%$	
Short-circuit if	$U_{output} < 6 V$ or $I > 30 A$	

Table 12.4: Electrical output characteristics

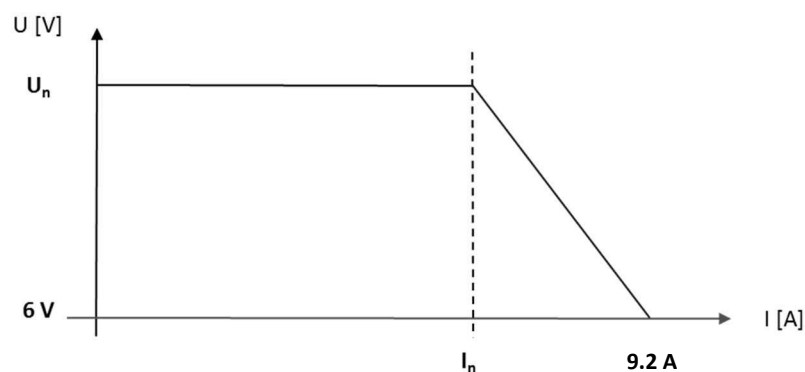

Figure 12.3: Output voltage vs User current

### 12.1.3 Functional characteristics

A user output permanently supplies a constant voltage (12 V DC or 24 V DC) to the equipment which has to be powered. In the event of a mains failure, the built-in backup maintains the electrical power supply of the equipment connected to the UPS for the duration defined when the SDC-M IP was chosen.

An Ethernet connection allows to retrieve the information including the analogue values remotely (voltages and load current, backup, autonomy, internal electronic temperature).

By default, the DHCP is active. The HTTPS webserver makes it possible amongst others to configure the communication parameters and to choose the functioning mode.

On the front panel, there are also one status LED and two Ethernet status LEDs available.

The Stealth Mode function makes it possible to shed load from the mains while guaranteeing backup autonomy.

### 12.1.4 Peak current

The figure and table below show the maximum peak current duration in ms for an output voltage > 80%  $U_n$ .

	12 V	24 V
$I/I_n$	Time [ms]	
5	4	1.6
3	7	3.7
2	12	8
1.5	22	12
1.2	60	40
1.1	100000	100000

Table 12.5: Overload capacity

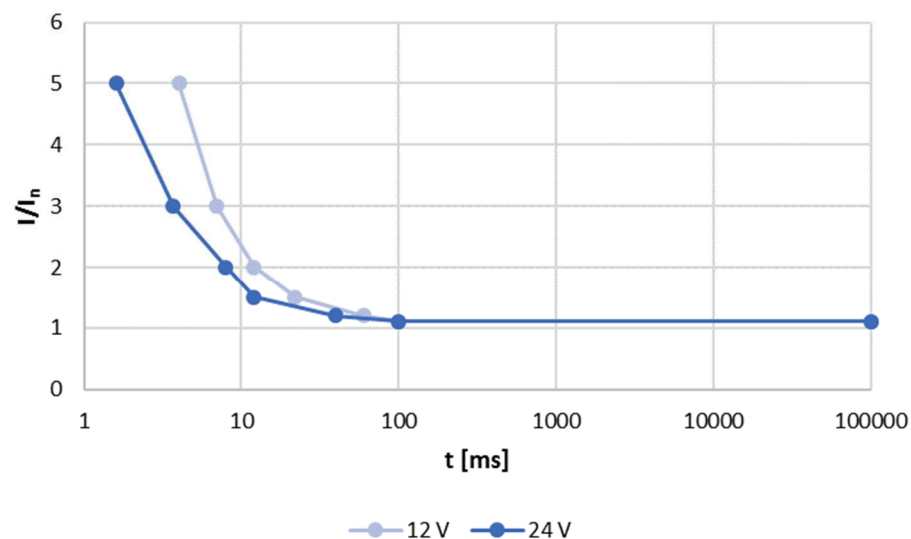

Figure 12.4: Overload capacity curve

## 12.2 Mechanical characteristics

Mechanical specifications		
Envelope	Aluminium	
Protection rating	IP20	
Size	DIN1 box	W 100 x H 124 x D 82 mm
	DIN2 box	W 100 x H 124 x D 122 mm
Weight	DIN1 box	0.68 kg (backup D)
	DIN2 box	1.36 kg (backup G)
Installation	Box to be attached to a DIN rail	

Table 12.6: Mechanical specifications

## 12.3 Environmental specifications

Environmental specifications		
Storage temperature		-25 ... +60°C
Operating temperature	in emergency supply or normal mode	-10 ... +55°C
	in battery charging mode	-5 ... +55°C
Relative humidity	in storage	10 ... 95%
	operating	20 ... 95%
Altitude	Above 2,000 m, the temperature decreases by 5% every 1,000 m.	

Table 12.7: Environmental specifications

## 12.4 Standards

The product is designed to meet with LV and EMC directives (immunity and emission). It complies with the following standards.

### 12.4.1 Safety standards

Section	Standard number	Title/Content
LVD Safety	EN 62368-1 (2020)	Audio/video, information and communication technology equipment - Part 1: Safety requirements.

Table 12.8: Safety standards

### 12.4.2 EMC standards

Section	Standard number	Title/Content
Immunity	EN 61000-6-1 (March 2007)	Immunity for residential, commercial and light-industrial environments (generic standard)
Immunity	EN 61000-6-2 (January 2006)	Immunity standard for industrial environments (generic standard)
Emissions	EN 61000-3-2 (August 2006) (class A)	Limits for harmonic current emissions (equipment input current $\leq 16$ A per phase)
Emissions	EN 61000-6-3 (March 2007)	Emission standard for residential, commercial and light-industrial environments (generic standard)
Emissions	EN 61000-6-4 (March 2007)	Emission standard for industrial environments (generic standard)
Emissions	EN 55032 (2015) (class B)	Electromagnetic compatibility of multimedia equipment

Table 12.9: EMC standards

## 13. Warranty and Product Returns

---

### 13.1 Warranty

The equipment is guaranteed for three years from the date of delivery (ex-works). It is strictly limited to reimbursement or replacement (at our discretion and without compensation of any sort) of parts recognized as faulty by our services, following the return of the product to our premises at the buyer's expense. The replacement or repair of equipment is possible only on our premises. In order to allow our customers to benefit from the latest technical improvements, SLAT reserves the right to make all necessary modifications to its products.



---

#### **IMPORTANT REMARK!**

**Mechanical opening of the product cancels the manufacturer warranty!**

---

### 13.2 Product Returns

#### 13.2.1 Product under warranty

For the maintenance of your products under warranty, SLAT offer the best solution to facilitate your repairs and minimize lead times:

- Contact the Customer Service department using the form available on our web site [www.slat.com](http://www.slat.com) , taking care to fill in all the required fields.
- The RMA form will be processed and sent back by the SLAT account manager.
- After receiving your RMA form, return two copies with your product(s), one INSIDE the package and the other on the OUTSIDE of the package for warehouse identification purposes, thereby guaranteeing traceability of your product.
- The repaired or replaced product(s) will be returned within a maximum of 15 business days.

### 13.2.2 Product not under warranty

#### Product repair by SLAT

Contact Customer Service at [service.client@slat.fr](mailto:service.client@slat.fr), making sure to provide all of the following information:

- Last name/First Name
- Company / Complete Address / Phone / Email
- Exact model of the product (indicated on the product label) / SLAT reference (indicated on the product label, code number) / Serial No. / Quantity / Problems(s) encountered (describe the faults encountered with the product)

The form to request the RMA number is also available at [www.slat.com](http://www.slat.com).

The account manager will send the RMA form by email together with a quote according to the relevant product range.

After receiving your RMA form, return two copies with your product(s), one INSIDE the package and the other on the OUTSIDE of the package for warehouse identification purposes, thereby guaranteeing traceability of your product. The repairs will be made only after the receipt of the accepted quote together with the repair order form. If the quote is rejected, please return it to [service.client@slat.fr](mailto:service.client@slat.fr) marked "refused" and specify whether the equipment should be destroyed or returned in its existing condition (in this case a charge of €150 will be invoiced for handling costs).

The repaired or replaced product(s) will be returned within a maximum of 15 business days. A new 3 month warranty is attributed to the relevant product.

**Conditions: Authorization to return products is issued by SLAT.**

**An RMA number is assigned to each product to be returned. Each RMA number is valid for 30 days.**

**No equipment may be returned without prior issuance of an RMA number.**



SLAT

11, Rue Jean Elysée Dupuy BP66  
69543 Champagne au Mont d'Or Cedex  
FRANCE

Tel.: +33 478 66 63 60

Fax: +33 478 47 54 33

e-mail: [comm@slat.fr](mailto:comm@slat.fr)

SLAT GmbH

Leitzstraße 45  
70469 Stuttgart  
DEUTSCHLAND

Tel.: +49 711 899 890 08

Fax: +49 711 899 890 90

E-mail: [info@slat-gmbh.deselectio](mailto:info@slat-gmbh.deselectio)



[www.slat.com](http://www.slat.com)