



SYNAPS

Network connection interface

SYNAPS 12/24V 3E IP



SLAT SAS

11 rue Jean Elysée Dupuy - BP66
69543 Champagne au Mont d'Or - France

+33 4 78 66 63 70

comm@slat.fr

www.slat.com

SLAT GmbH

Leitzstraße 45

70469 Stuttgart ☐ Deutschland

+49 711 899 890 92

info@slat-gmbh.de

www.slat.com

EN OPERATING INSTRUCTIONS

TABLE OF CONTENTS

TABLE OF CONTENTS	2
1 LIST OF PRODUCT DESIGNATIONS	4
2 SAFETY	4
3 DEFINITION OF SYMBOLS	5
4 GENERAL INFORMATION	6
4-1 THE COMPANY	6
4-2 PURPOSE OF THESE INSTRUCTIONS.....	6
4-3 RELATED DOCUMENTATION	6
4-4 INTENDED AUDIENCE.....	6
4-5 TYPES OF NOTIFICATION	6
5 THE PRODUCT.....	7
5-1 DESCRIPTION	7
5-2 SCHEMATIC DIAGRAM	7
5-3 PRODUCT VIEWS.....	8
5-4 CONTENTS OF THE DELIVERY	9
6 INSTALLING THE CABINET	10
6-1 WALL-MOUNTING OR PULL-BOX MOUNTING	10
6-2 POLE-MOUNTING.....	10
6-3 MECHANICAL SPECIFICATIONS	11
7 FIXING ACCESSORIES	12
8 CONNECTING TO THE MAINS	13
8-1 RECOMMENDATIONS	13
8-2 WIRING METHODS.....	13
8-3 CONNECTION	13
9 ELECTRICAL CONNECTION OF THE APPLICATION	14
9-1 RECOMMENDATIONS	14
9-2 WIRING METHODS.....	14
9-3 CONNECTING THE SECONDARY VOLTAGE	14
10 CONNECTING TO THE NETWORK.....	15
10-1 RECOMMENDATIONS	15
10-2 WIRING METHODS.....	15
10-3 ETHERNET NETWORK CHARACTERISTICS	15
10-4 ELECTRICAL AND COMMUNICATION OUTPUT SPECIFICATIONS.....	15
10-5 NETWORK PROTECTION PROTOCOLS	16
10-6 INSTALLING THE ROOT CERTIFICATE	16
10-7 ASSIGNING AN IP ADDRESS.....	16
11 SYNAPS BACKUP	17

11-1	AVAILABLE STORAGE OPTION.....	17
11-2	DESCRIPTION	17
11-3	OPERATING PRINCIPLE.....	17
11-4	TECHNOLOGY.....	17
11-5	AUTONOMY CURVE AND DURATION.....	18
12	EMBEDDED WEBSERVER	19
12-1	LOGIN PAGE - LOGGING ONTO THE PRODUCT	19
12-2	CONFIGURATION PAGE - CONFIGURING THE GENERAL SETTINGS.....	19
12-3	NETWORK PAGE - CONFIGURING THE IP CONNECTION AND ETHERNET INFORMATION	21
12-4	POWER SUPPLY PAGE - CONFIGURING THE POWER SUPPLY	24
12-5	SYSTEM STATE PAGE - ACCESSING SYSTEM INFORMATION	25
12-6	LOG PAGE - ACCESSING THE EVENTS LOG	26
12-7	FACTORY CONFIGURATION RESET	29
12-8	SHUTTING DOWN THE PRODUCT	29
13	OPERATION.....	29
13-1	REMOTE REPORT - COMMUNICATION	29
13-2	ACCESSIBLE DATA	30
13-3	HTTPS PROTOCOL	30
13-4	SNMP PROTOCOL.....	31
13-5	BACNET IP PROTOCOL	32
14	TECHNICAL DATA	38
14-1	ELECTRICAL CHARACTERISTICS MAINS INPUT	38
14-2	SECONDARY VOLTAGE ELECTRICAL CHARACTERISTICS	39
14-3	FUNCTIONAL CHARACTERISTICS	39
14-4	PEAK CURRENTS.....	40
14-5	ENVIRONMENTAL SPECIFICATIONS	40
14-6	SAFETY STANDARDS.....	41
14-7	EMC STANDARDS	41
15	MAINTENANCE AND TROUBLESHOOTING.....	42
15-1	MAINTENANCE.....	42
15-2	TROUBLESHOOTING.....	42
16	WARRANTY AND PRODUCT RETURNS	43
16-1	WARRANTY	43
16-2	PRODUCT RETURNS	43
16-3	PRODUCT NOT UNDER WARRANTY	43

1 LIST OF PRODUCT DESIGNATIONS

These operating instructions apply to all the products listed in the table below.

Table 1-1 - List of product designations

DESIGNATION	CODE
SYNAPS 12V 3E IP	700160039
SYNAPS 24V 3E IP	700160040

2 SAFETY

This manual contains all the instructions to follow to install, commission and use the SYNAPS network connection interface. Please follow them very carefully to ensure the product functions correctly. It is vital to read the Safety Instructions before installing or commissioning this product.

SAFETY INSTRUCTIONS

SYNAPS is designed to be connected to the 110 - 240 V AC public mains supply which has a frequency of 45 to 65 Hz.

- A disconnect switch or circuit breaker must be installed upstream in accordance with the current regulations.
- To avoid any risk of electrocution, the disconnect switch or circuit breaker must be opened before any maintenance work is carried out on the equipment.
- Work must only be carried out by qualified personnel.
- During installation, connect the ground first and when dismantling, disconnect it last.
- Ensure the product is the right way round (see photo on page one of the chapter entitled [Product Installation](#)).
- EN 62368-1 compliance (This equipment is not suitable for use in places where children are likely to be present).
- Provide sufficient convection (clearance of at least 50 mm).
- The equipment is only designed to be installed or mounted on a non-combustible surface.
- Size and protect the cables in accordance with the maximum input / output current ($\geq 0.15 \text{ mm}^2/\text{A}$).
- Observe the thermal and mechanical limits.
- Caution! There is a risk of explosion if the battery is not an original part supplied by SLAT!
- Recycle the product and its battery at the end of its life in accordance with the instructions.
- The backup is maintenance-free. Do not open it.
- In case of extended storage or disconnection, switch off the mains power supply and follow the procedure described in the [Product shutdown](#) paragraph in the chapter entitled [Embedded webserver](#).

3 DEFINITION OF SYMBOLS



Compliance of the product with the requirements of the European directives.



WEEE (WASTE ELECTRICAL AND ELECTRONIC EQUIPMENT)

Dispose of the product in an appropriate recovery and recycling centre.
This product must not be disposed of with the household waste.



RoHS (RESTRICTION OF HAZARDOUS SUBSTANCES)

Compliance with the European directive restricting the use of certain hazardous substances in electrical and electronic equipment.



Protective ground terminal.



Caution, risk of electric shock.



The product must be recycled at the end of its life. The various components can be easily separated. A plug-in connector allows the backup to be easily removed by qualified professionals independent of SLAT.

SLAT is committed to protecting the environment and public health. SLAT designs and manufactures all its products in line with the RoHS and WEEE environmental directives.

4 GENERAL INFORMATION

4-1 THE COMPANY

To better satisfy its customers' expectations:

- ☒ SLAT designs and manufactures all its products according to standard ISO 14001 v15.
- ☒ SLAT recycles its products at the end of their life cycle by means of its recycling programme.

4-2 PURPOSE OF THESE INSTRUCTIONS

These operating instructions provide the information necessary to set up, connect, configure and operate the SYNAPS 12/24V 3E IP equipment.

These instructions are also available in PDF format from the MySLAT space at www.slat.com.

4-3 RELATED DOCUMENTATION

The following documents are related to these operating instructions:

- ☒ Installation manual
- ☒ Commercial brochure

This documentation is available at www.slat.com.

4-4 INTENDED AUDIENCE

The operations and information described in these instructions must only be performed by authorised, trained operators.

4-5 TYPES OF NOTIFICATION

Three types of important notifications are used in these instructions. The type of notification informs you of the potential consequences of non-compliance with the instructions.

These consequences are not exhaustive and are listed in order of increasing risk.



IMPORTANT REMARK!

Contains additional information. Non-compliance will not cause damage to equipment or injury.



CAUTION!

Equipment and property may be seriously damaged or people may be seriously injured if the precautions for use are not followed.



DANGER!

Failure to comply with the notification may lead to serious injury or death.

5 THE PRODUCT

5-1 DESCRIPTION

SYNAPS 12/24V 3E IP is a network connection interface.

SYNAPS is installed as close as possible to the applications and offers every benefit to optimise wiring : It also enables selective electrical protection of the applications.

The benefits of SYNAPS

- ☑ Eliminates brown-outs and provides emergency power appropriate to your needs.
- ☑ Protects equipment against lightning and electromagnetic disturbances.
- ☑ Designed for outdoor use, with IP65 watertight and IK10 vandalism-proof locked cabinet.
- ☑ Ultra compact and lightweight product.
- ☑ Monitoring by secure protocols: HTTPS / SNMP V1, V2c and V3 / BACnet IP.



- ☑ Eliminates brown-outs and provides emergency power appropriate to your needs.

5-2 SCHEMATIC DIAGRAM

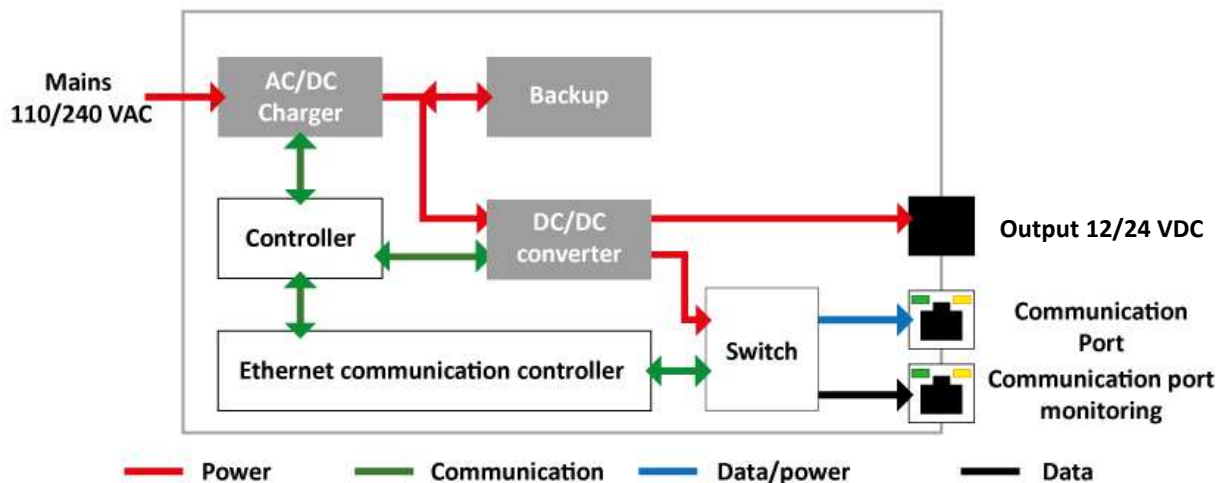

5-3 PRODUCT VIEWS

Exterior



Interior

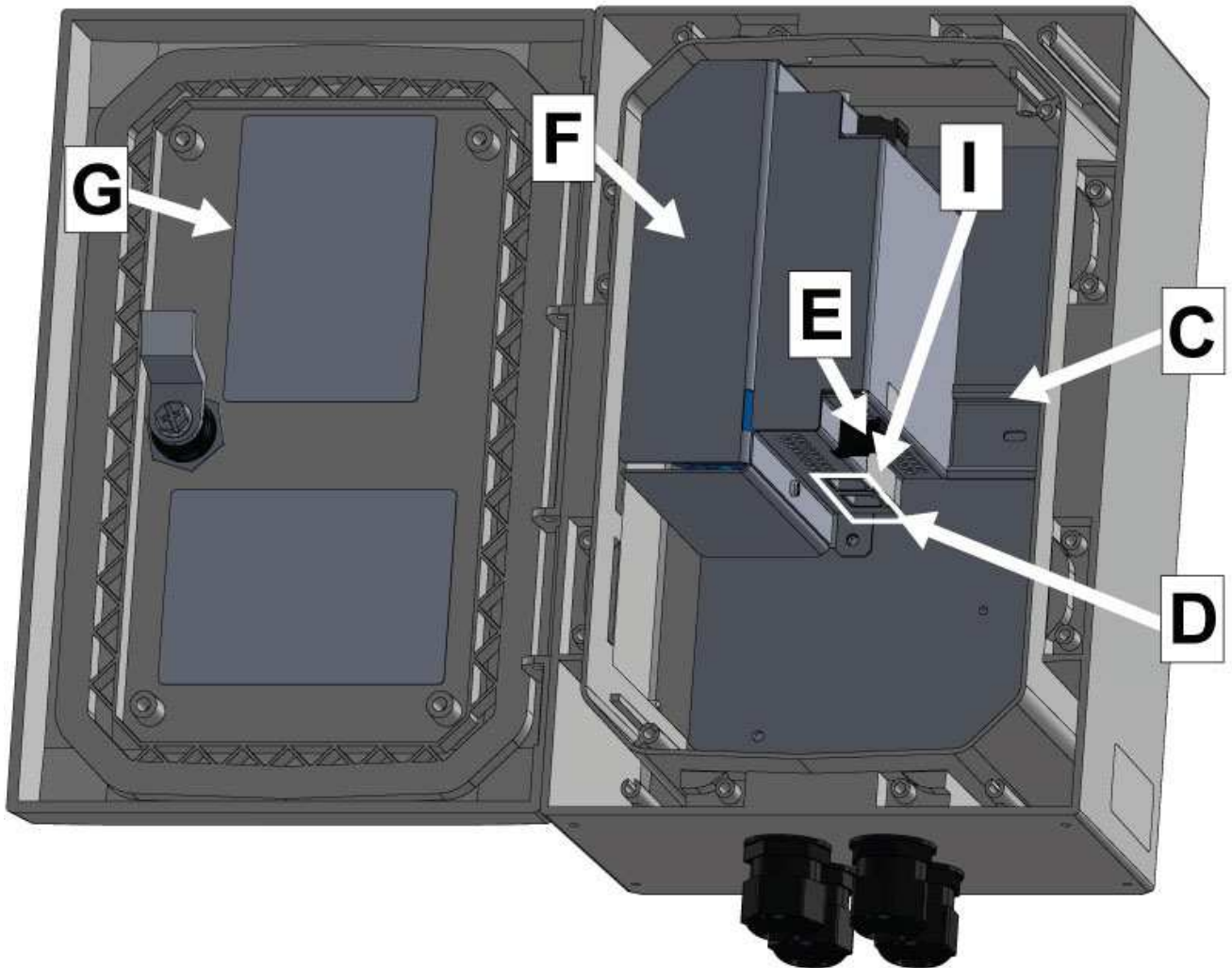

H

surge arrester

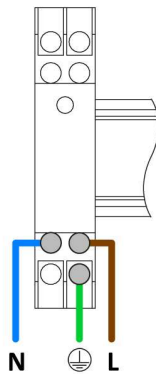
**Location and legend of components**

	NAME	USE
A	Handle with key lock	Door opening vs closing and protection with key.
B	Cable gland	Cable feedthrough for all cables including RJ45 cables.
C	DIN rail	Mounting of customer equipment.
D	Ethernet ports	Communication uses an Ethernet connection and SNMP, HTTPS and BACnet IP protocols to retrieve detailed information about the product (10/100 Mbps).
E	DC output	12/24 V DC user voltage output.
F	MAC address	Identifies the SYNAPS over the Ethernet network.
G	Connection label	Location of connection points and the backup disconnect button for extended storage.
H	Mains	110 - 240 V AC mains input.
I	Backup disconnect push-button	The push-button is used to switch off the power supply once the mains supply is cut off or to return to the factory settings when the mains supply is present.

5-4 CONTENTS OF THE DELIVERY

The product is delivered with:

- ➡ The installation manual

6 INSTALLING THE CABINET

The product must be installed according to safety standards EN 62368-1. It can be installed in an unventilated area.

The SYNAPS 12/24V 3E IP is designed to be installed vertically on a wall, in a pull-box or on a pole.

6-1 WALL-MOUNTING OR PULL-BOX MOUNTING

1. Place the product against the wall (on a concrete substrate for example) and mark the fastening points or use the dimensions stated in this manual (holes for 4 screws).
2. Drill the substrate and insert 4 plugs (not supplied ☒ $\varnothing 6 \times 50$ mm recommended).
3. Attach the product using 4 screws (not supplied ☒ $\varnothing 5 \times 50$ mm recommended).
4. Use washers with a diameter of 10 mm.

Cooling the product by natural convection requires a minimum clearance of 50 mm on each side.

The figure opposite shows how the cabinet should be positioned after mounting on the wall.

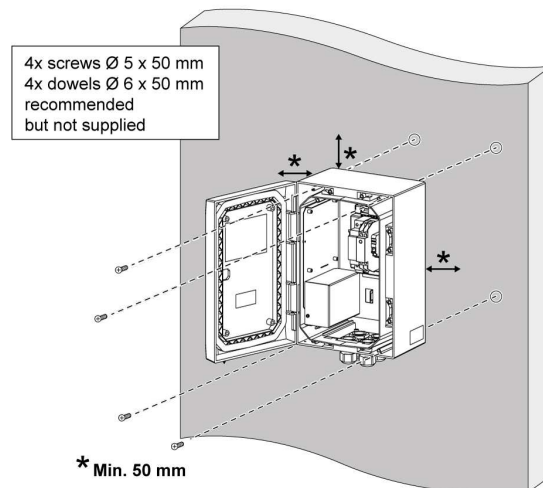

6-2 POLE-MOUNTING

1. Mount the kit on the product using a bit screwdriver [$\frac{1}{4}$ " socket and $\frac{1}{8}$ " hex bit (H6)].
2. Attach the product to the pole using the clamp (\varnothing min. 100 ☒ max. 300 mm).

The figure opposite illustrates how the mounting kit should be fitted to the cabinet and positioned on the pole.

The installer is responsible for checking the load capacity of the pole.

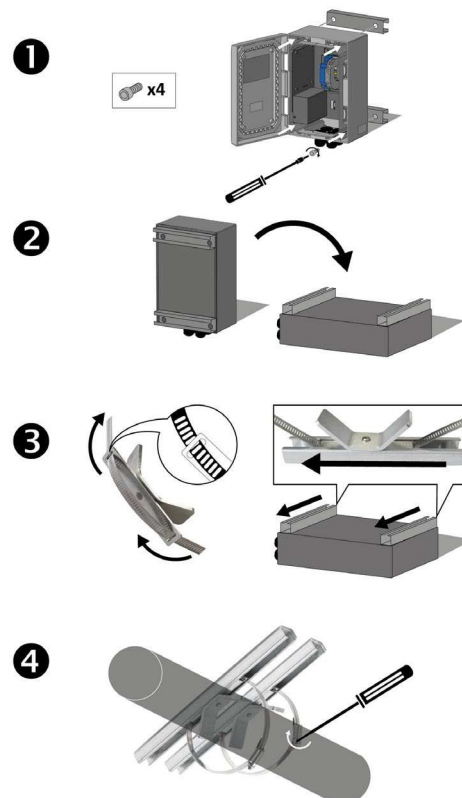

6-3 MECHANICAL SPECIFICATIONS

MECHANICAL SPECIFICATIONS	
Cabinet	Polycarbonate
Protection rating	IP 65
Impact resistance	IK10
Dimensions (cabinet)	L 200 x H 300 x D 150 mm
Overall dimensions	L 200 x H 332 x D 171 mm
Available customer space 1	L 44 x H 160 x D 115 mm
Available customer space 2	L - x H - x D - mm
Weight	3,4 kg
SCx (air resistance)	0.66
Installation	Wall-, pull box- or pole-mounted box

7 FIXING ACCESSORIES

- ➔ The pole mounting kit (optional)



- ➔ The wall mounting kit (optional)



- ➔ An anti-vandal kit (optional)



8 CONNECTING TO THE MAINS

8-1 RECOMMENDATIONS

- ☑ Network voltage: 110/240 VAC (99-264 VAC).
- ☑ Frequency: 50-60 Hz (45-65 Hz).
- ☑ Class I.
- ☑ Neutral systems: TT, TN, IT.
- ☑ Circuit breaker recommended upstream: curve C/D (rating 2 A).
- ☑ Primary current:
 - @ 110 VAC : 1 A @ 240 VAC : 0,45 A
 - @ 99 VAC : 1,5 A @ 264 VAC : 0,75 A

Surge arrester: type 2 -10 kA

Cable cross-section 0.3 to 2.5 mm² - Length to be stripped 7 mm - tightening torque 0.5 to 0.6 N.m.



DANGER!

The cable cross-section used must be selected according to the operating current. ($\geq 0.15 \text{ mm}^2/\text{A}$)

8-2 WIRING METHODS

Connect the cables according to the symbols on the label (flat screwdriver).



CAUTION!

Comply with the recommended screw tightening torque to avoid breaking the equipment.
Make a careful note of the positioning of the pieces of equipment and their respective symbols to avoid any wiring mistakes.
Altering the pre-wiring on the product could cause it to malfunction and would invalidate the warranty.

8-3 CONNECTION



DANGER!

The application must be switched off in order to connect the equipment.
The circuit breaker upstream of the application must be open!
The stripped parts of the mains cables must be crimped before being connected to the product terminals!
Always connect the ground wire first before connecting the power supply to the mains!

The mains input cables must be connected to the surge arrester. Connect the three wires according their colour:

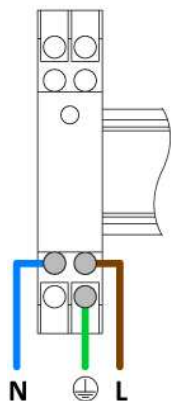

- Yellow/green - ground wire
- Blue - neutral wire (N)
- Brown - live wire (L)

After connecting the ground wire, the ☑neutral☑ and ☑live☑ wires can be connected.

9 ELECTRICAL CONNECTION OF THE APPLICATION

9-1 RECOMMENDATIONS

Cable cross-section 0.3 to 2.5 mm² - Length to be stripped 7 mm



DANGER!

The cable cross-section used must be selected according to the operating current. ($\geq 0.15 \text{ mm}^2/\text{A}$)

9-2 WIRING METHODS

Connect the cables according to the symbols on the label (flat screwdriver for screw terminals).



CAUTION!

Make a careful note of the positioning of the terminals to avoid any wiring mistakes.

Altering the pre-wiring on the product could cause it to malfunction and would invalidate the warranty.

9-3 CONNECTING THE SECONDARY VOLTAGE

The product is connected to the application by the two-point screw terminal (see diagram below).

The initial output voltage is set to the rated value 12/24 V DC.



DANGER!

The application must be switched off in order to connect the equipment.

The circuit breaker upstream of the application must be open!

The stripped parts of the mains cables must be crimped before being connected to the product terminals!

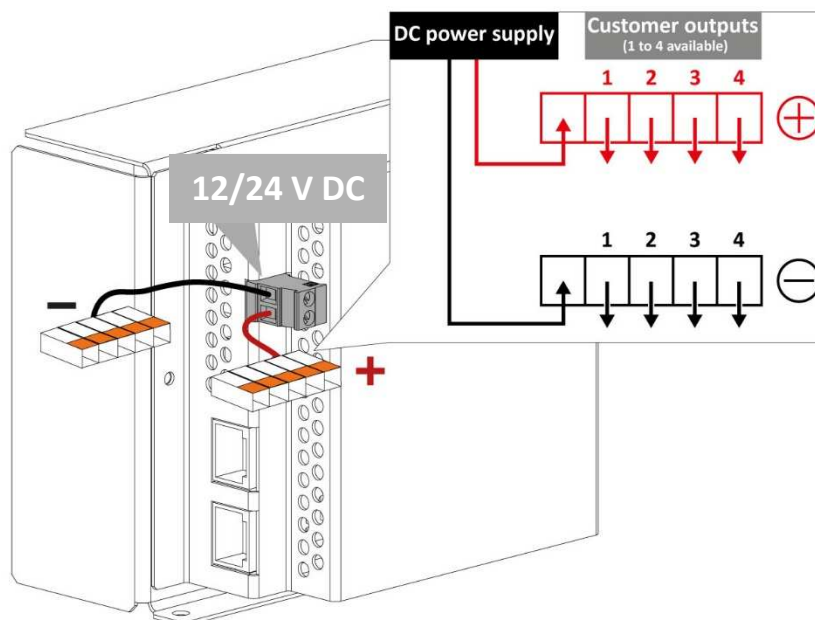

The upstream circuit breaker can be closed once connection is complete.

10 CONNECTING TO THE NETWORK

10-1 RECOMMENDATIONS

The Ethernet cable must have the following properties:

Ethernet cable - shielded or unshielded - straight or crossed cable - Cat. 5 or more.

10-2 WIRING METHODS

The communication cables are connected to the product by Ethernet ports. They are auto MDI-X ports so straight or crossed cables can be used.



CAUTION!

Make a careful note of the positioning of the connectors to avoid any wiring mistakes.

Altering the pre-wiring on the product could cause it to malfunction and would invalidate the warranty.

Connect the two Ethernet ports (RJ45)

- Connect the Ethernet input to the top to communicate with the supervisor (see diagram).
- Connect the IP application to the other Ethernet port.

The RJ45 connector latching tab should be positioned to the front.

Information concerning communication:

The communication speed of the two Ethernet ports is 10/100 Mbps.

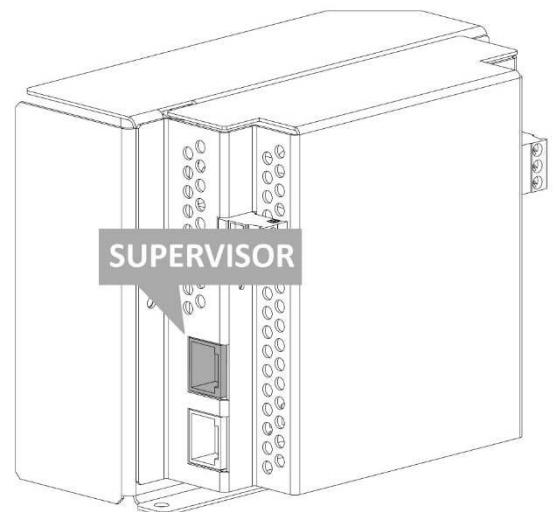

10-3 ETHERNET NETWORK CHARACTERISTICS

Before starting to commission the power supply, check that the UPS DC Status LED is green. This means that the product is correctly powered and ready to function.

The communication parameters can be configured via the HTTPS website. It can also be used to configure energy saving mode (ECO) and stealth mode.

In order to communicate with the product, it must be configured according to the following chapters. The configuration of the network of the computer to which the product will be connected must be compatible with the product's network parameters.

10-4 ELECTRICAL AND COMMUNICATION OUTPUT SPECIFICATIONS

Electrical outputs

Communication outputs

□ Port Ethernet 100 Mbps : 2

10-5 NETWORK PROTECTION PROTOCOLS

The product supports the following communication protocols. They can run simultaneously. Therefore it is not necessary to select a single active protocol.

Application protocols: ➡ HTTPS ➡ BACnet IP ➡ DHCP ➡ SNMP v1, v2c + v3
Network protocols: ➡ IPv4 ➡ ICMP

10-6 INSTALLING THE ROOT CERTIFICATE

To use the products in HTTPS and communicate safely with them the SLAT root certificate must be installed on the user's computer. This certificate is valid for all SLAT products and can be downloaded from MySlat on www.slat.com.

The root certificate is called SLAT_ca_cert.crt

The certificate must be installed in the certificate store: Trusted root certification authorities

Selecting the certificate store

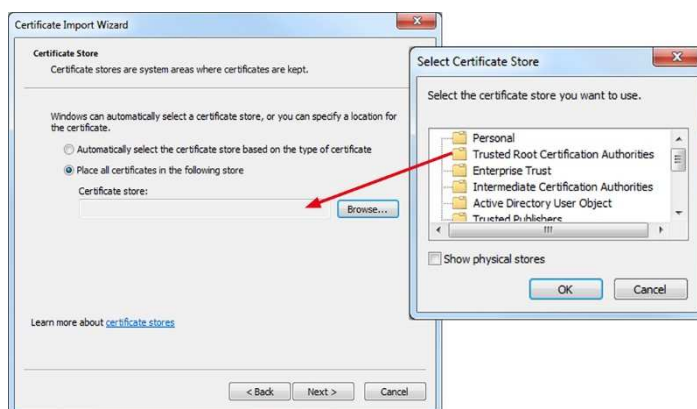

10-7 ASSIGNING AN IP ADDRESS

The DHCP (dynamic IP address allocation) automatically assigns an IP address to a product in order to communicate with it. This feature is enabled by default in the factory configuration.

There are two operating modes depending on the availability or lack of a DHCP server on the network:

A. DHCP server available

If a DHCP server is available, it allocates an IP address to the product. If several products are connected to the network, it allocates a different IP address to each one.

Browse the network to determine the new address.

B. DHCP server unavailable

If no DHCP server is available on the network, the product uses the IP parameters below. When the product connects to the network for the first time, it remains in DHCP for 1 minute before switching to the predefined IP address.

➡ IP address **192.168.1.1** ➡ IP address **No gateway**
 ➡ Network mask **255.255.255.0**

In this case, if several products need to be connected to the same network, as they all have the same IP parameters, they must be isolated and the IP address of each product must be modified with the HTTPS web interface before being connected to the network in order to avoid any IP address conflicts. The same procedure is valid if the same IP address exists several times on a given network. See the chapter entitled Embedded webserver to change the IP address.

11 SYNAPS BACKUP

11-1 AVAILABLE STORAGE OPTION

SLAT products are combined with backup systems. They are used as emergency power supplies if the mains supply is cut off. The available autonomy then depends on the capacity of the built-in backup.

The backup (Smart Backup Inside) integrated into the SYNAPS 12/24V 3E IP represents a minimum guaranteed power supply of 40Wh.

11-2 DESCRIPTION

SYNAPS 12/24V 3E IP with "Smart Backup Inside" is lead-free, cadmium-free and has a very long service life.

The built-in Li-ion backup (Micro-UPS DC - Uninterruptible Power Supply) for security systems. In the event of a power outage or glitch, it ensures continuity of service for the equipment it powers with its integrated backup function and maintains communication with the supervisor.

Built-in functions

- ☑ Keeps control of sensitive building and infrastructure equipment during power outages and glitches.
- ☑ Avoids false alarms being reported to the supervisor due to network glitches.
- ☑ Delivers a constant voltage to the equipment.
- ☑ Operates in power-saving mode when the backup is charged.
- ☑ Indicates the % remaining autonomy.

11-3 OPERATING PRINCIPLE

When connected to the mains, the UPS DC SYNAPS stores energy and continuously powers the connected devices.

During glitches or when the mains supply fails, the built-in emergency supply continues to provide power to the connected devices without interruption.

In the event of a complete discharge, the recharging time to 100% of the backup will in all cases be less than 20 hours of mains presence.

11-4 TECHNOLOGY

The SYNAPS 12/24V 3E IP backup system uses lithium iron phosphate technology (LiFePO₄). LiFePO₄ offers the best safety characteristics of any lithium storage system (see illustration below). This includes better resistance to impacts and to extreme temperatures.

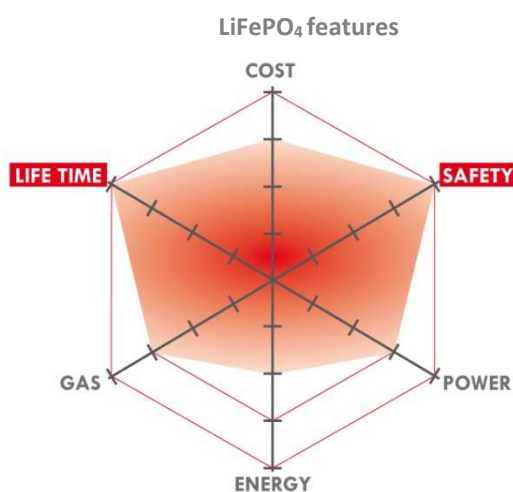

The SYNAPS 12/24V 3E IP backup has the following features:

- ➔ Lithium iron phosphate technology (LiFePO₄)
- ➔ No risk of thermal runaway
- ➔ Storage for 9 months without recharging
- ➔ 10-Year service life at 25°C
- ➔ Lead-free, cadmium-free, 100% recyclable

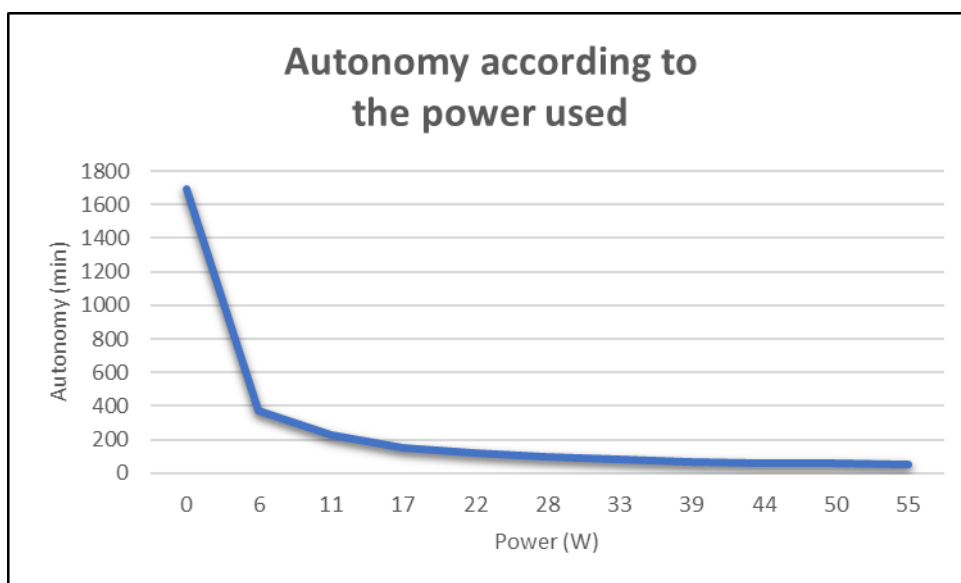
11-5 AUTONOMY CURVE AND DURATION

12 EMBEDDED WEBSERVER

Before starting to commission the power supply, check that the UPS DC Status LED is green. This means that the product is correctly powered and ready to function

The communication parameters can be configured via the HTTPS website. It can also be used to configure energy saving mode (ECO) and stealth mode.

In order to communicate with the product, it must be configured according to the following chapters. The configuration of the network of the computer to which the product will be connected must be compatible with the product's network parameters.

12-1 LOGIN PAGE - LOGGING ONTO THE PRODUCT

Login page

You can log onto the product using a web browser (over HTTPS) using the allocated or predefined IP address. The language used is that of the web browser.



IMPORTANT REMARK!

The default login and password are:

Login: admin

There is no password. Click directly on **OK**.

It is essential to set a password for the security of your installation!

Once connection with the product has been established, the **SYSTEM STATE** page opens (see chapter 12-5, page 25). If no password has been set, the **CONFIGURATION** page opens (see chapter 12-2) and a message informs you that a password needs to be set. The default language of the administrator's embedded website is English.

12-2 CONFIGURATION PAGE - CONFIGURING THE GENERAL SETTINGS

Configuration page

To configure the product, click on the **CONFIGURATION** tab in the left-hand menu. This page is used to perform the following configuration operations. Confirm the operations using the button next to them (**OK**, **Add**, **Delete**, **Update**).

1. Change language**2. Change password****3. Add user**

Up to 8 users (including the administrator) can be created. By default, the user account is created in the same language as that of the administrator. It can be changed if necessary.

A new user does not need to enter a password. The first time the new user logs in, he/she will be able to enter a new password via the [CONFIGURATION](#) page.

4. Delete user**5. Enter the system name**

A name with up to 16 characters can be entered for the system. Over HTTPS, the name always has the prefix [SYNAPS](#). This information is also available over SNMP and BACnet IP but without the prefix.

6. Enter the product location

The location defined here is shown on the [SYSTEM STATE](#) page (see chapter 12-5, page 25). This information is also accessible over SNMP and BACnet IP.

7. Update the firmware (communication)

The communication firmware can be updated to add new functions. The current version is displayed in the top right-hand corner of the page.

Operations 1 and 2 can be performed by all the accounts (administrator and users). However, operations 3 to 7 can only be performed by the administrator.

12-3 NETWORK PAGE CONFIGURING THE IP CONNECTION AND ETHERNET INFORMATION

Network page

SLAT **SYNAPS**

Network

Port	Link	IP Address	
Port1 -	-	0.0.0.0	OK
Port2 -	100Mb/s	0.0.0.0	OK

Update

Green Ethernet (EEE): OK

DHCP:

System IP Address: 192.168.1.1

Network Mask: 255.255.255.0

Gateway IP Address: 0.0.0.0 OK

NTP Server IP Address #1: 0.0.0.0

NTP Server IP Address #2: 0.0.0.0

System Timezone Offset (minutes): 0 OK

BACnet: Read-Only OK

SNMP: V3 - Read-Only

USM User:

Auth Algorithm: MD5

Auth Password:

Privacy Algorithm: DES-CBC

Privacy Password: OK

SNMP Server IP Address #1: 0.0.0.0 OK

SNMP Server IP Address #2: 0.0.0.0 OK

[SNMP MIB Download](#)

CHAPTER

1

2

3

4

5

6

7

To configure the IP connection, click on the NETWORK tab in the left-hand menu. This page displays all connection-related information (e.g. connected ports, IP address).

The administrator can access and edit all the information.

Users can only view the information concerning each port (1) and the product's IP parameters (3).

1. CONFIGURING THE PORTS

The table shows the configuration and state of each of the ports on the SYNAPS-IP. To save changes made to a port, click on **OK** to the right of the same row.

➔ Port

This column contains the port identifier. It can be customized as required by entering a name of up to 11 characters in the right-hand box.

If an IP address has been entered in the **IP Address** column, then the word **Port X** is a hypertext link to this same IP address ([Port X](#)).

➔ Link

This column indicates whether an Ethernet link has been established, displaying the connection speed: Ports 1 to 2: 10 or 100 Mbps

➔ IP address

This field is used to enter an IP address. If this IP address is different to **0.0.0.0**, it changes the **Port X** identifier to a hypertext link to this same IP address.

Updating the information

The information is automatically refreshed every 10 seconds, except when an edit operation is in progress. The information can be manually refreshed by clicking on the **Update** button.

2. GREEN ETHERNET CONFIGURATION (EEE ENERGY-EFFICIENT-ETHERNET)

The Green Ethernet function makes it possible to automatically reduce the power consumption of an Ethernet link depending to its usage. To save the Green Ethernet configuration, select the box then click **OK** to the right of the same row.

Some incompatibilities can cause the Ethernet link to be unstable. In this case you are advised to disable Green Ethernet.

3. CONFIGURING THE SYNAPS-IP PRODUCT IP PARAMETERS

The product's IP parameters consist of the IP address, network mask and gateway IP address. These parameters can be automatically assigned by DHCP, or entered manually. DHCP is enabled by default. It is only possible to function in DHCP if a DHCP server is available on the network.

The following paragraph explains how to change the product's IP parameters:

➔ Automatic IP parameter assignment

The DHCP must be enabled for automatic assignment (box to the right of DHCP selected). Click on the **OK** button next to **Gateway IP Address**. The DHCP server allocates a new IP address to the product. Explore the network to determine the new address.

➔ Manually entering the IP parameters

DHCP must be disabled in order to enter the IP parameters manually (box to the right of DHCP deselected). Enter the new parameters into the three fields below (product IP address, network mask and gateway IP address). If the gateway feature is to be disabled, enter the gateway IP address **0.0.0.0**. Click on **OK** next to **Gateway IP Address** to save the configuration. The user is automatically re-routed to the new address (login page).

4. CONFIGURING NTP

The NTP servers (Network Time Protocol) are used to synchronize the system clock. Proceed as follows:

- ➔ Enter the IP address of one or two NTP servers to obtain UTC time.
- ➔ Enter the offset in minutes between the system time zone and the UTC time to correctly date events. The value range in minutes can be from -720 to +720, which covers all time zones.
- ➔ To save the settings, press **OK** to the right of the **System Timezone Offset** line.

5. CONFIGURING THE BACNET IP PROTOCOL

The BACnet IP protocol can operate in one of the following modes:

- ➔ Read/Write
The data is accessible in read and write mode via the BACnet IP protocol. Actions can be implemented.
- ➔ Read Only (default mode)
The data is only accessible in read mode via the BACnet IP protocol.
- ➔ Disabled
The BACnet IP protocol is disabled.

Click on **OK** to the right of **BACnet** to save the configuration.

6. CONFIGURING THE SNMP PROTOCOL

The product supports SNMP versions V1, V2c and V3. The SNMP protocol can operate in one of the following modes:

- ➔ Read/Write
The data is accessible in read and write mode via the SNMP protocol. Actions can be implemented.
- ➔ Read Only (default mode)
The data is only accessible in read mode via the SNMP protocol.
- ➔ Disabled
The SNMP protocol is disabled.
SNMP V1 and V2c: Click on **OK** to the right of **SNMP** to save the configuration.

SNMP V3:

- ➔ USM User
Create a login.
- ➔ Auth Algorithm
Choose the algorithm to hash the password corresponding to the login.
- ➔ Auth Password
Enter a password of between 8 and 16 characters.
- ➔ Privacy Algorithm
Choose the encryption algorithm.
- ➔ Privacy Password
Enter an encryption code of between 8 and 16 characters.
Click on **OK** to the right of **Privacy Password** to save the configuration.
If the user wishes to receive SNMP traps, he/she must configure the IP address of the SNMP servers receiving them.

To save changes, click on **OK** to the right of the same row. If the feature is to be disabled, enter the IP address **0.0.0.0**.

Two SNMP servers can be entered.

7. LOADING THE MIB

The MIB (Management Information Base) can be downloaded via the link. If the download does not start, check that it is not blocked by the web browser.

12-4 POWER SUPPLY PAGE - CONFIGURING THE POWER SUPPLY

The **POWER SUPPLY** page contains information relating to the battery and its use. Only the administrator can edit this information. Users can only consult it.

Power supply page

The screenshot shows the 'Power supply page' in the SLAT web interface. The page title is 'SYNAPS' and the firmware version is 'Firmware V2.3A Support'. The left sidebar contains navigation options: '> System State', '> Power Supply' (highlighted in red), '> Network', '> Log', '> Configuration', and '> Disconnection'. The main content area is titled 'Power Supply' and contains the following configuration options:

Battery:	Capacity	<input type="text" value="20 Wh"/>
Stealth Mode:	Threshold	<input type="text" value="Disabled"/> <input type="button" value="OK"/>
Eco Mode:	Threshold	<input type="text" value="Disabled"/> <input type="button" value="OK"/>
Output:	Voltage adjustment	<input type="button" value="-"/> <input type="button" value="+"/> <input type="text" value="12.02 V / +0.0%"/> <input type="button" value="OK"/>
	State	<input type="text" value="Password"/> <input type="button" value="On"/> <input type="button" value="v"/>

Battery

The capacity displayed is the battery's minimum capacity. The value is given for information purposes and cannot be changed. It differs from the typical value for the capacity given on the product label.

Stealth mode

Stealth mode enables the supervision to stop product consumption to relieve network load. The product automatically switches to normal operation once the remaining autonomy has reached the guaranteed autonomy percentage selected by the administrator during configuration.

To enable the stealth mode, the threshold (percentage of the guaranteed autonomy when stealth mode is used) must be defined: 25% / 50% / 75% / Disabled. Click on **OK** to the right to save the new threshold.

Eco mode

When enabled, eco mode improves power efficiency at low charge (<20% of I_{max}), while guaranteeing a defined percentage of autonomy. Eco mode is disabled by default in the factory settings.

To enable eco mode, the threshold (percentage of the autonomy that must remain available to the user) must be defined: 50% / 60% / 70% / 80% / Disabled. Click on **OK** to the right to save the new threshold.

Output

The factory setting of the output voltage is U_n. This value can be adjusted via the HTTPS website to compensate for cable lengths. The value can vary from -8% to +13% of U_n.

The voltage is adjusted using the **+** and **-** buttons. Adjustment is made in 0.1% increments, accelerating when the button is pressed and held down. Click on **OK** to the right to save the changes.

To modify the power supply output status (stop, start or restart), enter the password and select the desired status. The status changes and the **System state** page updates automatically.

12-5 SYSTEM STATE PAGE - ACCESSING SYSTEM INFORMATION

Once connection with the product has been established, the **SYSTEM STATE** page opens. The Figure and the paragraph below describe the information displayed on this page.

System state page

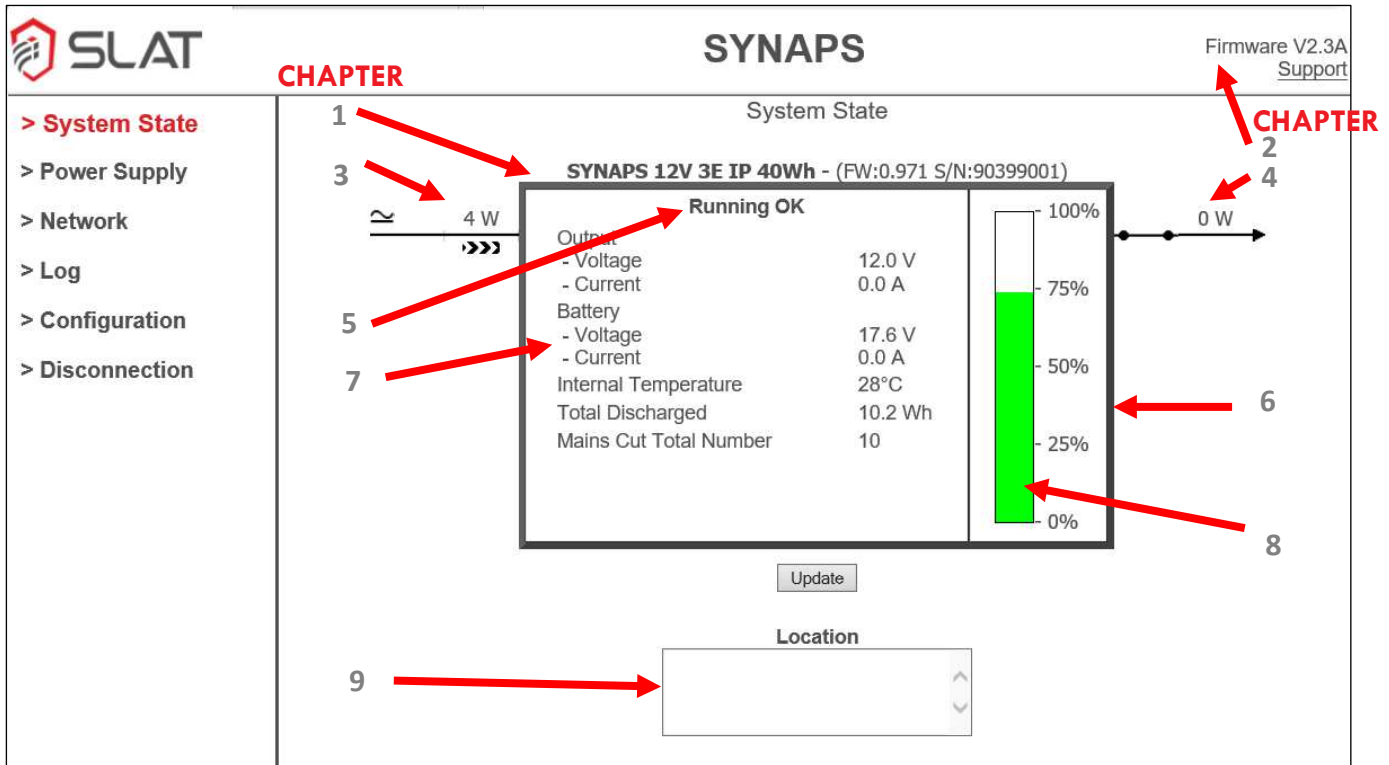

The **System State** page displays the operating status and all the physical values measured by the product. It is refreshed every 10 seconds. Click on the **Update** button to refresh the data manually.

1. PRODUCT DESCRIPTION

- ➔ Reference and version
- ➔ Actual capacity in watt-hours
- ➔ Power supply firmware and serial number

2. COMMUNICATION FIRMWARE VERSION AND SUPPORT

You can use the **Support** link to send an email to the SLAT after-sales service.

3. MAINS INPUT

Mains power is indicated by the pictogram on the left in the **System state page** figure. If no mains power is present, a red cross is displayed over the pictogram. The value displayed indicates mains consumption in watts.

4. OUTPUT

When the switch is closed, the application is powered by the product. If the switch is open, the backup is reaching the end of its autonomy: disconnection and interruption of the power supply are imminent. The value indicates the total power supplied to the application in watts.

5. PRODUCT OPERATING STATUS

The text indicates whether the product is operating correctly or whether there is a product fault.

6. OPERATING MODE

The product operating mode is indicated by the frame colour:

- ➔ Operating on mains **grey frame**
- ➔ Operating on backup **orange frame**
- ➔ Eco or stealth mode **green frame**

7. OPERATION-RELATED DATA

- ➔ Output voltage and current.
- ➔ Battery voltage and current.
If the displayed battery current is negative, the battery is discharging.
- ➔ Internal temperature of the SYNAPS.
- ➔ Total watt-hours drained from the SYNAPS backup since product factory inspection and commissioning.
- ➔ Total number of power cuts since product factory inspection and commissioning.

CHARGE GAUGE

The gauge shows the backup pack's charge status. The backup pack must be fully charged once before the gauge will display an accurate reading.

LOCATION

The location defines the place where the product is installed. This information can be changed in the [CONFIGURATION](#) page.

12-6 LOG PAGE - ACCESSING THE EVENTS LOG

To access the event log, click on the [Log](#) heading in the menu on the left. This page displays the event history. It can be filtered in four categories: power, network, configuration and miscellaneous. The history can contain up to 100 events, the oldest being deleted automatically. The filtered event list can be downloaded in text form.

Log page

1. Time stamp

If the date and time are available via the NTP (see [24] NTP configuration, page 23), then the events are time stamped in the following format:

hours: minutes: seconds day/month/year
 E.g. ↻ 16:10:50 13/12/2018 - System Start
 16:10:53 13/12/2018 - P2: 100Mbps
 10:48:58 14/12/2018 - Mains Fault
 10:48:58 14/12/2018 - Backup Mode
 10:55:26 14/12/2018 - Mains OK

Otherwise, the time elapsed since the last start-up is used pending the availability of NTP data. In this case, the events are in the following format:

hours: minutes: seconds number of days J
 E.g. ↻ 00:00:00 0D - System Start
 00:00:00 0D - Reset Configuration
 00:00:01 0D - Mains Fault
 00:00:01 0D - Backup Mode
 00:00:03 0D - P1: 100Mbps

2. Syslog

The product is able to send events via UDP / 514 to one or two syslog servers (RFC 5424 and RFC 5426). Enter the level of severity of the events to be sent and the IP address(es) of the servers.

LEVEL	DESCRIPTION	EVENT SEVERITY			
		ALL	< 5	< 4	DISABLED
0	Emergency System is unusable.	✓	✓	✓	
1	Alert Action must be taken immediately.	✓	✓	✓	
2	Critical Critical conditions for the system.	✓	✓	✓	
3	Error Operating error.	✓	✓	✓	
4	Warning Warning (An error may occur if no action is taken).	✓	✓		
5	Notice Normal event but requiring notification.	✓			
6	Informational Information	✓			

The category code used for the priority of SysLog messages is 1.

3. Events list

Events related to the power converter

TYPE OF EVENT	SEVERITY LEVEL	COMMENT
End of backup	0	Backup at the end of autonomy. Imminent shutdown.
Short circuit	2	Short circuit on output.
Charger fault	2	Charger malfunction: the product must be changed.
Converter fault	2	Output converter malfunction: the product must be changed.
Battery fault	2	Battery malfunction: the product must be changed.
Backup mode	4	The product is operating in Backup out of Green mode.
Overload	4	Output consumption > 100% of the nominal value (current limitation to limit the output power).
Mains fault	4	No mains.
Temperature fault	4	Internal temperature too high.
High consumption	5	Output consumption > 95% of the nominal value.
Normal mode	6	Normal operation on mains.
Green mode	6	Mains present, the product is in stealth mode or energy-saving mode (ECO)
Consumption OK	6	Normal output consumption.
Stealth request	6	Receipt of an external instruction to operate in stealth mode.
Stop stealth request	6	Receipt of an external instruction to stop stealth mode.
Mains OK	6	The mains power supply is present.
Temperature OK	6	Internal temperature OK.
Charger OK	6	The charger is operating correctly.
Converter OK	6	The output converter is operating correctly.
Battery OK	6	Battery OK.
Output off	6	Output converter stop command.
Output on	6	Output converter start command.
Output restart	6	Output converter restart command (stops for 8 seconds).

P* → Port 1 and 2

Events relating to the network

TYPE OF EVENT	SEVERITY LEVEL	COMMENT
Link fault	4	Event activated when a port is disconnected or an Ethernet link is lost. The event is active until it is acknowledged For details of the variable see System state table - Bit 26 - Ethernet failure).
Link fault acknowledgement	6	Acknowledgement of the Link fault event.
P* - No link	6	State of the port P* Ethernet link.
P* - 10 Mbps	6	
P* - 100 Mbps	6	

P* → Port 1 and 2

Events related to configuration

TYPE OF EVENT	SEVERITY LEVEL	COMMENT
Configuration reset	5	Resets factory configuration, see 12-7 page 29.
Configuration changed	6	Event generated 2 minutes after the last product configuration change.

Events related to the system

TYPE OF EVENT	SEVERITY LEVEL	COMMENT
System start	5	Generated when the system starts up or reboots

12-7 FACTORY CONFIGURATION RESET

In order to return to the original settings, a factory configuration reset must be performed by pressing and holding down the disconnect backup push button for 10 seconds, with mains power present [see **BACKUP PUSH BUTTON** on the **connection label**]. The factory configuration reset concerns all user-definable parameters, including DHCP. The total watt-hours drained and the number of power cuts displayed on the **System State** page are not reset.



IMPORTANT REMARK!

To perform the factory configuration reset, the product must be connected to the mains, or it will be switched off.

12-8 SHUTTING DOWN THE PRODUCT

To shut down the product:

- ➔ Switch off the mains power supply.
- ➔ Open the cabinet door.
- ➔ Press the disconnect backup push button [see “BACKUP PUSH BUTTON” on the “connection label”].

13 OPERATION

It is possible to interact with the product while it is in use thanks to remote report **Communication**

13-1 REMOTE REPORT - COMMUNICATION

When using the product, it is possible to communicate with it remotely using the built-in communication system. The Ethernet connection makes it possible to:

- ➔ retrieve information remotely
- ➔ have more details about the types of faults
- ➔ communicate analogue values (user voltages and currents, remaining backup percentage, internal temperature, autonomy)
- ➔ configure the power supply

The product communicates its information on the Ethernet connection via the HTTPS, SNMP and BACnet IP application protocols.

The information and explanations on how to configure the product are described in the chapter entitled **Embedded webserver**. The following chapters describe the information available via the different protocols.

13-2 ACCESSIBLE DATA

The following data is accessible over SNMP and BACnet IP.

Details of the **System state** variable

BIT	NAME	DESCRIPTION
27 - 31	- Reserved -	-
26	Ethernet fault	In read mode, if the bit is at 1, then one or more Ethernet links have been lost. The fault remains active even if the links are restored. To acknowledge the fault, set the bit to 1 in write mode, which then switches to 0 in read mode.
25	Halt stealth mode	Set bit to 1 in write mode to stop stealth mode. The bit remains at 0 in read mode.
24	Stealth mode start / status	In read mode, if the bit is at 1, then stealth mode is enabled. Set bit to 1 in write mode to start stealth mode.
20 - 23	- Reserved -	-
19	Communication fault	Internal communication error if the bit is at 1. The values of the read data are not significant.
18	Initialisation fault	Initialisation of the internal communication in progress if the bit is at 1. The values of the read data are not significant.
16 - 17	- Reserved -	-
15	High battery current	If the bit is at 1, then the battery current is too high.
14	High battery voltage	If the bit is at 1, the product must be replaced: the battery voltage is too high.
13	End of autonomy	End of autonomy pre-alarm when the bit is at 1 (shutdown is imminent).
12	Battery fault	If the bit is at 1, the product must be replaced: the battery is faulty or has been removed.
11	Rectifier fault	If the bit is at 1, the product must be replaced: the charging system is faulty and the battery may not be charged.
10	Mains fault	If the bit is at 1, mains power is absent.
9	Output overload	If the bit is at 1, the output is overloaded.
8	Output short circuit	If the bit is at 1, the output is short-circuited.
7	High temperature	If the bit is at 1, the temperature in the product is too high.
6	Battery disconnection	If the bit is at 1, the battery is disconnected.
5	Stealth mode or eco mode	If the bit is at 1, stealth mode or eco mode is activated.
4	Intrusion detection	When the option is present, if the bit is at 1, box tampering or removal detection is enabled.
0 - 3	- Reserved -	-

Details of the **Ethernet port X state** variable

BIT	NAME	DESCRIPTION										
26 - 31	- Reserved -	-										
24 - 25	Ethernet State	Ethernet port state: <table border="1"> <thead> <tr> <th>VALUE</th> <th>STATE</th> </tr> </thead> <tbody> <tr> <td>00</td> <td>No link</td> </tr> <tr> <td>01</td> <td>10 Mbps link</td> </tr> <tr> <td>10</td> <td>100 Mbps link</td> </tr> <tr> <td>11</td> <td>1000 Mbps link</td> </tr> </tbody> </table>	VALUE	STATE	00	No link	01	10 Mbps link	10	100 Mbps link	11	1000 Mbps link
VALUE	STATE											
00	No link											
01	10 Mbps link											
10	100 Mbps link											
11	1000 Mbps link											

13-3 HTTPS PROTOCOL

The HTTPS website provides product management and data processing-related information.

The chapter entitled **Embedded webserver** describes the use of the HTTPS website and the various data available. To log onto the embedded website, use the selected login and password. The chapter entitled **Configuration page - configuring the general settings** describes how to change the password.

13-4 SNMP PROTOCOL

2 MIBs are accessible over SNMP:

- ➔ The MIB-2, defined by the RFC1213 standard.
- ➔ The MIB SLAT-SDC is proprietary and specific to SLAT. It is common to the entire SYNAPS range. It can be downloaded from the embedded website (HTTPS) on the [Network](#) page.



IMPORTANT REMARK!

For the SNMP v1 and v2c, the Write Community is `private`.
For the SNMP v3, the user and the password must be configured.

MIB-2 variables

MIB-2		
VARIABLE	SNMP NAME	DESCRIPTION
Model	sysDesc	SYNAPS reference and version
Identifier	sysName	SYNAPS identifier (accessible in write mode, up to 16 characters)
Location	sysLocation	SYNAPS location (accessible in write mode, up to 32 characters)

MIB SLAT variables

MIB SLAT		
VARIABLE	SNMP NAME	DESCRIPTION
Model		SYNAPS reference and version.
Capacity	capacity	Battery capacity: energy expressed in watt-hours.
Serial number	serialNumber	SYNAPS serial number.
System state	systemState	32-bit variable giving the state of the SYNAPS system. Each time a change is made, this variable is sent in the form of an SNMP trap (for details of the variable, see System state table)*.
Gauge	energyGauge	Gauge in percentage corresponding to the amount of energy available in the battery. A value of 100 corresponds to a fully charged battery.
Output voltage	outputVoltage	Output voltage: the value is expressed in tenths of a volt.
Output current	outputCurrent	Output current: the value is expressed in tenths of an ampere.
Output power	outputPower	Instantaneous power supplied by the SYNAPS: the value is expressed in watts.
Mains power	mainsPower	Instantaneous mains power input: the value is expressed in watts.
Temperature	temperature	SYNAPS internal temperature: the value is expressed in °C.
Total discharged energy	totalDischargedEnergy	Amount of energy provided by the SYNAPS battery since initial commissioning: the value is expressed in tenths of a watt-hour.
Mains cut total number	mainsCutTotalNumber	Total number of power cuts since initial commissioning.
Output voltage adjustment	voutAdjust	Output voltage adjustment value. This value must be between 0 and 4095 for a nominal voltage variation of approximately -8% to +13%. The value 1536 corresponds to the nominal voltage.
Stealth mode threshold	stealthModeThreshold	Minimum battery charge level in percent for stealth mode. Accepted values: 25, 50, 75 or 100. The value 100 disables stealth mode.
Eco mode threshold	ecoModeThreshold	Minimum battery charge level in percent for eco mode. Accepted values: 50, 60, 70, 80 or 100. The value 100 disables eco mode.
Ethernet port X state:	ethernetPortX-State	32-bit variable giving the state of each Ethernet port, X representing the port number (for details of this variable, see Table Details of Ethernet port X).

* In order to use SNMP traps, the IP addresses of the SNMP servers to which the traps should be sent must be entered into the HTTPS website (see chapter entitled [Network](#) page).

13-5 BACNET IP PROTOCOL

The following objects are accessible in BACnet IP:

BACnet IP variables

PROPERTY	REMARK / VALUE	RW
Object_Identifier	Product instance, by default: 421000	RW-E
Object_Name	SYNAPS system name (max. 16 characters). By default: [?]	RW-E
Object_Type	DEVICE (8)	R
System_Status	OPERATIONAL (0) or STATUS_NON_OPERATIONAL (4) if not ready	R
Vendor_Name	[SLAT]	R
Vendor_Identifier	954	R
Model_Name	Type of product	R
Location	Product location (max. 32 characters). By default: [?]	RW-E
Firmware_Revision	Communication firmware version	R
Application_Software_Version	[?]	R
Protocol_Version	1	R
Protocol_Revision	12	R
Protocol_Services_Supported	read-property, write-property, who-has, who-is, device-communication control	R
Protocol_Object_Types_Supported	DEVICE, ANALOG_VALUE, POSITIVE_INTEGER_VALUE	R
Object_List [17]	device, analog-value 0 [?] 10, positive_integer_value 0...4	R
Max_APDU_Length_Accepted	1476	R
Segmentation_Supported	NO_SEGMENTATION (3)	R
APDU_Timeout	3000	R
Number_Of_APDU_Retries	3	R
Device_Address_Binding	-	R
Database_Revision	0	R
Serial_Number	Serial number	R

R: Read Property, W: Write Property, -E: Saved in EEPROM

Analog value Object 0

ANALOG VALUE OBJECT 0		
PROPERTY	REMARK / VALUE	RW
Object_Identifier	analog-value 0	R
Object_Name	[?Vout?]	R
Object_Type	ANALOG_VALUE (2)	R
Description	"Output Voltage"	R
Present_Value	Output voltage	R
Status_Flags	IN_ALARM: 0 FAULT: 0 OVERRIDDEN: 0 OUT_OF_SERVICE: 0	R
Event_State	NORMAL (0)	R
Out_Of_Service	FALSE (0)	R
Units	Volts (5)	R

R: Read Property, W: Write Property, -E: Saved in EEPROM

Analog Value Object 1

ANALOG VALUE OBJECT 1		
PROPERTY	REMARK / VALUE	RW
Object_Identifier	analog-value 1	R
Object_Name	ⓂoutⓂ	R
Object_Type	ANALOG_VALUE (2)	R
Description	"Output current"	R
Present_Value	Output current	R
Status_Flags	IN_ALARM: 0 FAULT: 0 OVERRIDDEN: 0 OUT_OF_SERVICE: 0	R
Event_State	NORMAL (0)	R
Out_Of_Service	FALSE (0)	R
Units	Amperes (3)	R
R: Read Property, W: Write Property, -E: Saved in EEPROM		

Analog Value Object 2

ANALOG VALUE OBJECT 2		
PROPERTY	REMARK / VALUE	RW
Object_Identifier	analog-value 2	R
Object_Name	ⓂPoutⓂ	R
Object_Type	ANALOG_VALUE (2)	R
Description	"Output power"	R
Present_Value	Output power	R
Status_Flags	IN_ALARM: 0 FAULT: 0 OVERRIDDEN: 0 OUT_OF_SERVICE: 0	R
Event_State	NORMAL (0)	R
Out_Of_Service	FALSE (0)	R
Units	Watts (47)	R
R: Read Property, W: Write Property, -E: Saved in EEPROM		

Analog Value Object 3

ANALOG VALUE OBJECT 3		
PROPERTY	REMARK / VALUE	RW
Object_Identifier	analog-value 3	R
Object_Name	ⓂPinⓂ	R
Object_Type	ANALOG_VALUE (2)	R
Description	"Input power"	R
Present_Value	Mains power	R
Status_Flags	IN_ALARM: 0 FAULT: 0 OVERRIDDEN: 0 OUT_OF_SERVICE: 0	R
Event_State	NORMAL (0)	R
Out_Of_Service	FALSE (0)	R
Units	Watts (47)	R
R: Read Property, W: Write Property, -E: Saved in EEPROM		

Analogue Value Object 4

ANALOG VALUE OBJECT 4		
PROPERTY	REMARK / VALUE	RW
Object_Identifier	analog-value 4	R
Object_Name	Temperature	R
Object_Type	ANALOG_VALUE (2)	R
Description	"Internal temperature"	R
Present_Value	Internal temperature	R
Status_Flags	IN_ALARM: 0 FAULT: 0 OVERRIDDEN: 0 OUT_OF_SERVICE: 0	R
Event_State	NORMAL (0)	R
Out_Of_Service	FALSE (0)	R
Units	Degree Celsius (62)	R
R: Read Property, W: Write Property, -E: Saved in EEPROM		

Analog Value Object 5

ANALOG VALUE OBJECT 5		
PROPERTY	REMARK / VALUE	RW
Object_Identifier	analog-value 5	R
Object_Name	BatteryGauge	R
Object_Type	ANALOG_VALUE (2)	R
Description	"Remaining autonomy"	R
Present_Value	Battery gauge	R
Status_Flags	IN_ALARM: 0 FAULT: 0 OVERRIDDEN: 0 OUT_OF_SERVICE: 0	R
Event_State	NORMAL (0)	R
Out_Of_Service	FALSE (0)	R
Units	Percent (98)	R
R: Read Property, W: Write Property, -E: Saved in EEPROM		

Analog Value Object 6

ANALOG VALUE OBJECT 6		
PROPERTY	REMARK / VALUE	RW
Object_Identifier	analog-value 6	R
Object_Name	Battery capacity	R
Object_Type	ANALOG_VALUE (2)	R
Description	"Installed battery capacity"	R
Present_Value	Battery capacity	R
Status_Flags	IN_ALARM: 0 FAULT: 0 OVERRIDDEN: 0 OUT_OF_SERVICE: 0	R
Event_State	NORMAL (0)	R
Out_Of_Service	FALSE (0)	R
Units	Watt hours (18)	R
R: Read Property, W: Write Property, -E: Saved in EEPROM		

Analog Value Object 7

ANALOG VALUE OBJECT 7		
PROPERTY	REMARK / VALUE	RW
Object_Identifier	analog-value 7	R
Object_Name	☒StealthModeThreshold☒	R
Object_Type	ANALOG_VALUE (2)	R
Description	"Minimum battery gauge level for Stealth Mode (25%, 50% or 75% - 100 disables Stealth Mode)"	R
Present_Value	Stealth Mode Threshold	R
Status_Flags	IN_ALARM: 0 FAULT: 0 OVERRIDDEN: 0 OUT_OF_SERVICE: 0	R
Event_State	NORMAL (0)	R
Out_Of_Service	FALSE (0)	R
Units	Percent (98)	R
R: Read Property, W: Write Property, -E: Saved in EEPROM		

Analog Value Object 8

ANALOG VALUE OBJECT 8		
PROPERTY	REMARK / VALUE	RW
Object_Identifier	analog-value 8	R
Object_Name	☒EcoModeThreshold☒	R
Object_Type	ANALOG_VALUE (2)	R
Description	"Minimum battery gauge level for Eco Mode (50%, 60%, 70% or 80% - 100% disables Eco Mode)"	R
Present_Value	Eco Mode Threshold	R
Status_Flags	IN_ALARM: 0 FAULT: 0 OVERRIDDEN: 0 OUT_OF_SERVICE: 0	R
Event_State	NORMAL (0)	R
Out_Of_Service	FALSE (0)	R
Units	Percent (98)	R
R: Read Property, W: Write Property, -E: Saved in EEPROM		

Analog Value Object 9

ANALOG VALUE OBJECT 9		
PROPERTY	REMARK / VALUE	RW
Object_Identifier	analog-value 9	R
Object_Name	☒TotalDischargedEnergy☒	R
Object_Type	ANALOG_VALUE (2)	R
Description	"Total discharged energy"	R
Present_Value	Total discharged energy	R
Status_Flags	IN_ALARM: 0 FAULT: 0 OVERRIDDEN: 0 OUT_OF_SERVICE: 0	R
Event_State	NORMAL (0)	R
Out_Of_Service	FALSE (0)	R
Units	Watt hours (18)	R
R: Read Property, W: Write Property, -E: Saved in EEPROM		

Analog Value Object 10

ANALOG VALUE OBJECT 10		
PROPERTY	REMARK / VALUE	RW
Object_Identifier	analog-value 10	R
Object_Name	☒ MainsCut ☒	R
Object_Type	ANALOG_VALUE (2)	R
Description	"Mains cut total number"	R
Present_Value	Number of power cuts	RW
Status_Flags	IN_ALARM: 0 FAULT: 0 OVERRIDDEN: 0 OUT_OF_SERVICE: 0	R
Event_State	NORMAL (0)	R
Out_Of_Service	FALSE (0)	R
Units	No units (95)	R
R: Read Property, W: Write Property, -E: Saved in EEPROM		

Positive Integer Value Object 0

POSITIVE INTEGER VALUE OBJECT 0		
PROPERTY	REMARK / VALUE	RW
Object_Identifier	positive-integer-value 0	R
Object_Name	☒ Default ☒	R
Object_Type	POSITIVE_INTEGER_VALUE (48)	R
Description	"System state register"	R
Present_Value	System state [32 bit]*	R
Status_Flags	IN_ALARM: 0 FAULT: 0 OVERRIDDEN: 0 OUT_OF_SERVICE: 0	R
Units	No units (95)	R
R: Read Property, W: Write Property, -E: Saved in EEPROM		

* See details of the ☒System state☒ variable.

Positive Integer Value Object 1

POSITIVE INTEGER VALUE OBJECT 1		
PROPERTY	REMARK / VALUE	RW
Object_Identifier	positive-integer-value 1	R
Object_Name	☒ StealthMode ☒	R
Object_Type	POSITIVE_INTEGER_VALUE (48)	R
Description	"Stealth mode operating"	R
Present_Value	Stealth mode disabled if null, else enabled	RW
Status_Flags	IN_ALARM: 0 FAULT: 0 OVERRIDDEN: 0 OUT_OF_SERVICE: 0	R
Units	No units (95)	R
R: Read Property, W: Write Property, -E: Saved in EEPROM		

Positive Integer Value Object 2

POSITIVE INTEGER VALUE OBJECT 2		
PROPERTY	REMARK / VALUE	RW
Object_Identifier	positive-integer-value 2	R
Object_Name	SerialNumber	R
Object_Type	POSITIVE_INTEGER_VALUE (48)	R
Description	"Serial number"	R
Present_Value	Serial number	R
Status_Flags	IN_ALARM: 0 FAULT: 0 OVERRIDDEN: 0 OUT_OF_SERVICE: 0	R
Units	No units (95)	R

R: Read Property, W: Write Property, -E: Saved in EEPROM

Positive Integer Value Object 3

POSITIVE INTEGER VALUE OBJECT 3		
PROPERTY	REMARK / VALUE	RW
Object_Identifier	positive-integer-value 3	R
Object_Name	Ethernet1	R
Object_Type	POSITIVE_INTEGER_VALUE (48)	R
Description	"1st Ethernet port state"	R
Present_Value	Port 1* state	R
Status_Flags	IN_ALARM: 0 FAULT: 0 OVERRIDDEN: 0 OUT_OF_SERVICE: 0	R
Units	No units (95)	R

R: Read Property, W: Write Property, -E: Saved in EEPROM

* For details of the variable, see the Ethernet port X state table.

**The table above is the object for Ethernet port 1. For port 2 use the same table with the following formulas:
(X = port number):**

- ➔ ObjectIdentifier ➔ positive-integer-value 2 + X
- ➔ Object Name ➔ EthernetX
- ➔ Description: ➔ Xth Ethernet port state
- ➔ Present value: ➔ Port X state

See details of the Present value - Port X state.

14 TECHNICAL DATA

14-1 ELECTRICAL CHARACTERISTICS MAINS INPUT

Mains input electrical characteristics

MAINS INPUT	
AC network voltage	240 V AC (99-264 V AC)
DC network voltage	140-375 V
Frequency	50-60 Hz (45-65 Hz)
Class	1
Inrush current	Limited by NTC
Neutral regime	TT, TN, IT
Primary short-circuit protection	Slow-blow fuse on the phase
Characteristics of the built-in fuse	2.5 A (slow-blow, internal)
Shock wave protection	Differential mode by varistor and filter
Primary current @	@ 110 VAC : 1 A A
	@ 240 VAC : 0,45 A A
	@ 99 VAC : 1,5 A A
	@ 264 VAC : 0,75 A A
Residual consumption in eco and stealth mode	< 1 W
Circuit breaker to be provided upstream	Curve C or D (recommended rating 2 A)

CURRENT BEHAVIOUR:

➔ Inrush current at start-up

Oscillogram - inrush current

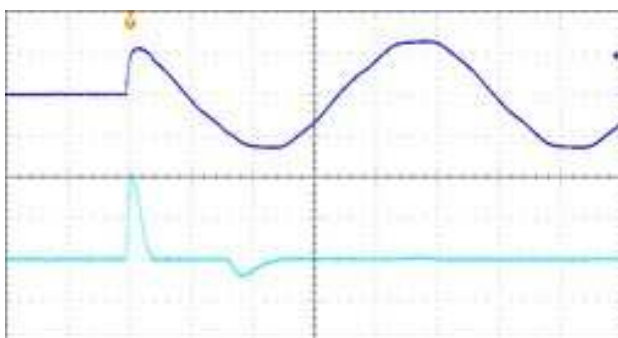

Description of the oscillogram - inrush current

TEST CONDITIONS	
Input voltage	240 V AC
Output voltage and current	12 V DC; no load
Ambient temperature	+20°C
DESCRIPTION OF THE DIAGRAM	
Upper curve	Input voltage (250 V / DIV)
Lower curve	Input current (20 A / DIV)
Time scale	4 ms / DIV

➔ Start-up sequence

Oscillogram - start-up behaviour

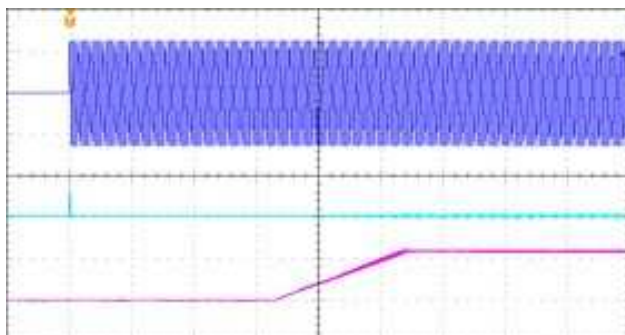

Description of the oscillogram start-up behaviour

TEST CONDITIONS	
Input voltage	240 V AC
Output voltage and current	12 V DC; 4.5 A
Ambient temperature	+20°C
DESCRIPTION OF THE DIAGRAM	
Upper curve	Input voltage (250 V / DIV)
Middle curve	Input current (20 A / DIV)
Lower curve	Output voltage (10 V / DIV)
Time scale	400 ms / DIV

14-2 SECONDARY VOLTAGE ELECTRICAL CHARACTERISTICS

Secondary voltage electrical characteristics

OUTPUT	
One user output	Constant DC voltage
Rated voltage U_n	12 V DC 24 V DC
Rated output current I_n	4.6 A 2.3 A
Permissible peak currents	9 A / 12 ms 4.6 A / 8 ms 23 A / 4 ms 11 A / 1.6 ms
Voltage precision	1%
Available output power	55 W*
Power limitation	P_{max} to $P_{max} + 10\%$ for output voltage > 6 V
Adjustment via HTTPS or SNMP	-8% ▢ +13%
Peak-to-peak HF residual ripple (20 MHz-50 Ω)	< 1.9% of U_n
Effective LF residual ripple	< 0.3% of U_n
Static and dynamic regulation characteristics	< 7% of U_n for cumulative variations of the mains and the load (from 10 to 90%)
Electronic	protection (no fuse)
η @ 20% of user load	85%
η @ 75% of user load	91%
η @ 100% of user load	90%
Protection against output short-circuit	by cutting off the power supply with cyclical restart
Protection against user output surges	deregulation or connection error, by cut-off with cyclical restart if output voltage > $U_n + 10\%$
Short circuit if	$U_{output} < 6 \text{ V}$ or $I > 30 \text{ A}$

* The permitted available output power with the SYNAPS 12/24V 3E IP is 55 W

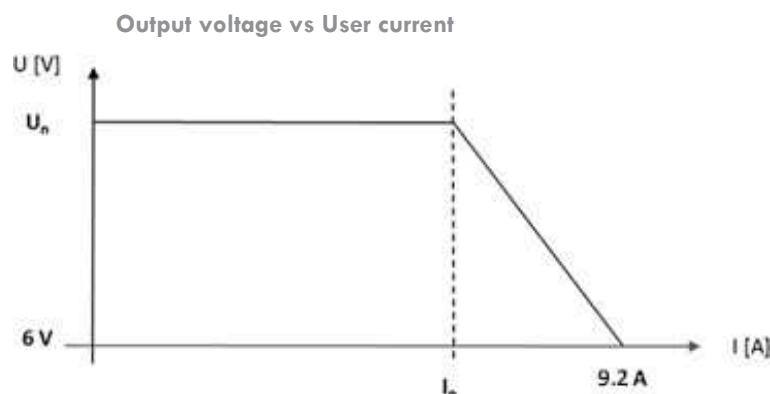

14-3 FUNCTIONAL CHARACTERISTICS

One user output permanently supplies a constant voltage (12/24 V DC) to the equipment which has to be powered. In the event of a power outage, the built-in backup maintains the electrical power supply to the equipment connected to the UPS for the duration defined when your SYNAPS 12/24V 3E IP was chosen.

An Ethernet connection is used to remotely retrieve information including the analogue values (user voltages and currents, backup, autonomy, internal electronic temperature).

The DHCP is active by default. The HTTPS webservice makes it possible to configure the communication parameters amongst other things, and to choose the operating mode.

A status LED and two Ethernet status LEDs are also available on the front.

The stealth function makes it possible to shed load from the network while guaranteeing backup autonomy.

14-4 PEAK CURRENTS

The figure and table below show the maximum peak current duration in ms for an output voltage > 80% Un.

Permissible overload capacity

	12 V	24 V
I/In	TIME [MS]	TIME [MS]
5	4	1.6
3	7	3.7
2	12	8
1.5	22	12
1.2	60	40
1.1	100000	100000

Overload capacity curve

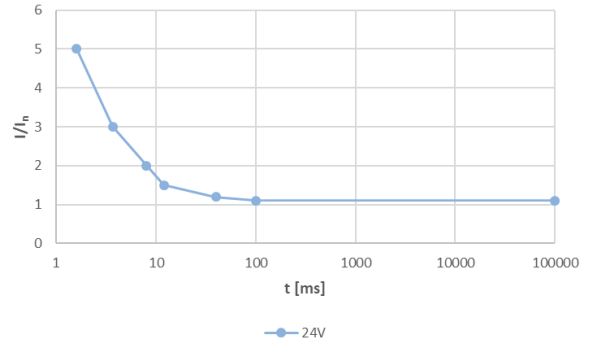
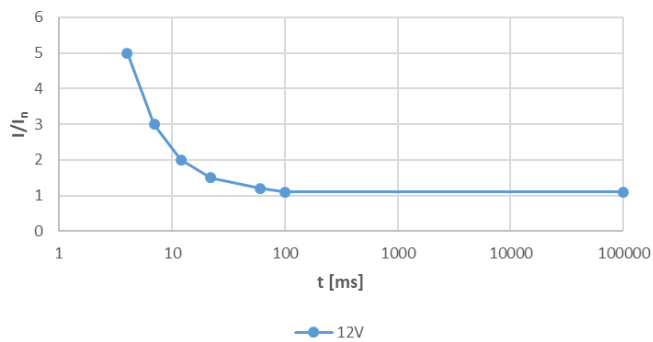

14-5 ENVIRONMENTAL SPECIFICATIONS

Environmental specifications

ENVIRONMENTAL SPECIFICATIONS	
Storage temperature	-25 °C to +60°C
Operating temperature	-40°C to 50°C
Relative humidity in operation	0% to 100% condensing
Altitude	Above 2000 m, the temperature is lowered by 5% every 1000 m.

14-6 SAFETY STANDARDS

The product is designed to meet the LV and EMC directives (immunity and emission).

SECTION	STANDARD NUMBER	TITLE/ CONTENT
LVD Safety	EN 62368-1 (2020)	Audio/video, information and communication technology equipment Part 1: Safety requirements

14-7 EMC STANDARDS

SECTION	STANDARD NUMBER	TITLE/ CONTENT
Immunity	EN 61000-6-1 (2007)	Immunity standard for residential, commercial and light-industrial environments (generic standard)
Immunity	EN 61000-6-2 (2005)	Immunity standard for industrial environments (generic standard)
Emission	EN 61000-6-3 (2007)	Emission standard for residential, commercial and light industrial environments (generic standard).
Emission	EN 61000-6-4 (2007) + A1 (2011)	Emission standard for industrial environments (generic standard).
Emission	EN 61000-3-2 (2014) (class A)	Limits for harmonic current emissions (equipment input current ≤ 16 A per phase).
Emission	EN 55032 (2015) (class B)	Electromagnetic compatibility of multimedia equipment.

15 MAINTENANCE AND TROUBLESHOOTING

15-1 MAINTENANCE

The product has been designed to function for a long period of time **without requiring maintenance**.



IMPORTANT REMARK!

Any work on the product must only be performed by qualified personnel. For additional technical assistance, contact the SLAT hotline: +33 4 78 66 63 70 For an RMA request (authorization to return goods), refer to chapter 3-2.



DANGER!

At no time should the cover of the charger power supply be opened, even for maintenance purposes.

15-2 TROUBLESHOOTING

Unexpected situations may arise during installation, commissioning or use. The table below may be consulted in case of problems. It contains a list of possible problems with their corresponding causes and solutions.

Problems, causes and solutions

PROBLEM	COMMUNICATION FAULT	CAUSE	SOLUTION
The product does not start.	No communication	The mains supply is not connected or is not present.	Check if the mains supply is correctly connected.
		The primary fuse is faulty or absent.	Replace the product.
There is no voltage at the output.	Output short circuit	Output overload or short-circuit.	Remove the short circuit.
The output voltage is lower than the normal value	Output overload	There is a slight overload on the output.	Lower the output load until the current is less than the maximum output value.
Temperature is too high	Temperature too high	Temperature is too high because the ambient temperature does not fulfil the specified conditions	Cool the installation.
The product's IP address has been lost.	No communication	-	Perform a factory configuration reset.
The administrator's password has been lost.	No communication	-	Perform a factory configuration reset.
A user's password has been lost.	No communication	-	Delete the user's account from the administrator's account.
No connection: The <i>Ethernet Link/Act LEDs</i> for the ports are not lit.	No communication	Poor Ethernet connection.	Check the connection and use a suitable Ethernet cable.
<i>The Ethernet Link/Act LEDs</i> are lit but not communicating.	No communication	Configuration problem.	Ensure that the SYNAPS and computer configurations are compatible.

16 WARRANTY AND PRODUCT RETURNS

16-1 WARRANTY

The equipment is guaranteed for two years from the date of delivery (ex-works). It is strictly limited to reimbursement or replacement (at our discretion and without compensation of any sort) of parts recognised as faulty by our services, following the return of the product to our workshops at the buyer's expense. The replacement or repair of equipment is possible only in our workshops. In order to allow our customers to benefit from the latest technical improvements, SLAT reserves the right to carry out any alterations considered appropriate.



IMPORTANT REMARK!

Mechanical opening of the covers of the sub-assemblies inside the product cancels **the manufacturer warranty!**

16-2 PRODUCT RETURNS

PRODUCT UNDER WARRANTY

For the maintenance of your products under warranty, SLAT offer the best solution to facilitate your repairs and minimise lead times:

- ➔ Contact the Customer Service department using the form available on our web site www.slat.com, taking care to fill in all the required fields.
- ➔ The RMA form will be processed and sent back by the SLAT account manager.
- ➔ After receiving your RMA form, return two copies with your product(s), one **INSIDE** the package and the other on the **OUTSIDE** of the package for warehouse identification purposes, thereby guaranteeing traceability of your product.
- ➔ The repaired or replaced product(s) will be returned within a maximum of 15 business days.

16-3 PRODUCT NOT UNDER WARRANTY

PRODUCT REPAIR BY SLAT

Contact Customer Services at service.client@slat.fr making sure that you provide all the following information:

- ➔ Last name / First name
- ➔ Company / Full address / Telephone / Email
- ➔ Exact model of the product (indicated on the product label) / SLAT reference (indicated on the product label, code number) / Serial No. / Quantity / Problems(s) encountered (describe the faults encountered with the product)

THE FORM TO REQUEST THE RMA NUMBER IS ALSO AVAILABLE AT WWW.SLAT.COM.

The account manager will send the RMA form by email together with a quote according to the relevant product range.

After receiving your RMA form, return two copies with your product(s), one **INSIDE** the package and the other on the **OUTSIDE** of the package for warehouse identification purposes, thereby guaranteeing traceability of your product. The repairs will be performed only after the receipt of the accepted quote together with a repair order form. If the quote is rejected, please return it to service.client@slat.fr marked **refused** and specify whether the equipment should be destroyed or returned in its existing condition (in this case a charge of €150 will be invoiced for handling costs).

The repaired or replaced product(s) will be returned within a maximum of 15 business days. A new three-month warranty is attributed to the product in question.

**CONDITIONS: AUTHORISATION TO RETURN PRODUCTS IS ISSUED BY SLAT.
AN RMA NUMBER IS ASSIGNED TO EACH PRODUCT TO BE RETURNED. EACH RMA NUMBER IS VALID FOR 30 DAYS. NO EQUIPMENT MAY BE RETURNED WITHOUT PRIOR ISSUANCE OF AN RMA NUMBER.**

For additional technical assistance, contact the SLAT hotline: +33 4 78 66 63 70



SLAT

SLAT SAS

11 rue Jean Elysée Dupuy - BP66
69543 Champagne au Mont d'Or - France
+33 4 78 66 63 70
comm@slat.fr
www.slat.com

SLAT GmbH

Leitzstraße 45
70469 Stuttgart ☐ Deutschland
+49 711 899 890 92
info@slat-gmbh.de
www.slat.com